



BIOLOGIX

Manufacturer and Supplier of Laboratory Consumables

Catalog 2014~2015 A3
www.BiologixGroup.com



BIOL@GLX[®]



Company Overview



Biologix Group Ltd is founded in USA in the year 2000 and has since been committed to the design and manufacture of high quality, low-priced scientific and biomedical supplies. Throughout its long company history, Biologix has excelled at providing top quality laboratory supplies to distributors at unbeatable prices. Time and time again, after consistently delivering on this promise and expectation, its customers have positioned Biologix among the top manufacturers of laboratory supplies in the world.

Most products manufactured in our U.S. FDA registered facilities are certified sterile, DNase and RNase Free, and non-pyrogenic using the highest quality, international famous medical-grade plastic materials. Some of the world's top branded laboratory supplies, in vitro diagnostic kits, and medical devices are also produced as OEM and/or Private Labeled products.

Biologix Group Ltd strives to provide its customers with just what they are looking for by engaging in market research and participating in continuous new product development. Your product needs and demands are important to us and our new product development system is designed to better support your needs as our customer. Our focus is on building long term relationships, allowing us to have a better understanding of the knowledge and experience you need to be successful in your market.

With 15 years of know-how, we have developed a focus on meticulous control, constant improvement and innovation, as well as setting standards of excellence in our industry. We are proud to serve thousands of laboratories across the United States, as well as hundreds of distributors around the world.

Your Partner for Success in Life Science!



Private Label and OEM

Biologix also operates as an OEM provider for plastic laboratory consumables. With in-house molding and tooling capabilities, we can provide the specific products needed around the world at significantly lower costs. Biologix is currently supplying some of the top global distributors with its OEM products.

Biologix also offers a Private Labeling Program to provide high quality, branded lab supplies at reduced prices. Many of the Biologix products are currently private labeled and sold worldwide by some of the most prominent brands/distributors.



Guaranteed Quality
Exceptional Service

Professional Design
Logical Pricing

Contact Information

Biologix Group Ltd
Tel: +1-816-6597165

Inquiry@BiologixGroup.com
www.BiologixGroup.com

CE ISO FDA



ISO9001:2008



CE Certificate



FDA Certificate

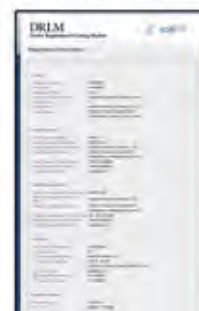

Order Information

How to Order

Biologix prefers wire transfers, but we also accept VISA and MasterCard. You can place order by telephone, fax, email. All orders can be shipped out by sea-freight, air-freight, courier to international customers normally within 30 days.

Biologix Ordering Information:

Tel: USA: +1-816-6597165

China: +86-531-67802668

Fax: China: +86-531-67803768

Email: Inquiry@BiologixGroup.com

www.BiologixGroup.com

Product Guarantee

Biologix guarantees 100% satisfaction or your money back! We guarantee the products to be free of defects in workmanship and material. Biologix will replace any defective products upon prompt notification and authorization.

Returned Products

Any return request must be authorized before credit is provided. Please provide the product, invoice number, and reason for the return. A restocking fee may apply. Products 30 days after delivery, special order/custom products are subject to review prior to issuing credit.

Join the Biologix Network

Now you can receive our monthly newsletter, special promotional opportunities by email, and much, much more! Visit our website and sign up to join the thousands of customers already enjoying the Biologix Benefits! Go to www.BiologixGroup.com and sign up today!

Free Product Samples





Let us send you a FREE sample package of our great products. Contact us today if you are interested in trying out the Biologix products before you buy.

Distribution

If interested in distribution opportunities, please contact us for distributor terms. We are accepting distribution opportunities worldwide.
Inquiry@BiologixGroup.com



Table of Contents

	Sample Centrifugation and Concentration	pg 7-12
	PCR	pg 13-17
	Cryogenic	pg 18-28
	Liquid Handling	pg 29-37
	Tissue Culture	pg 38-40
	Microbiology	pg 41-44
	Histology	pg 45-48
	Drosophila	pg 49-52
	Racks & Boxes	pg 53-54
	Gloves	pg 55

Sample Centrifugation and Concentration		Page
Centrifuge Tubes		8-9
Microcentrifuge Tubes		10
Test Tubes		11
Tube Racks		12
PCR		
PCR Tubes		14-15
PCR Strip Tubes		14-15
PCR Plates		16-17
Cryogenic		
Screw Cap Microtubes		20
Cryogenic Vials		21
Premium Cardboard Freezer Boxes		22
ID-Color™ Cardboard Freezer Boxes		23
PC Freezer Boxes		24
PP Freezer Boxes		25
Stainless Steel Freezer Racks		26-28
Liquid Handling		
Pipet Tips		30-33
Transfer Pipets		34
Solution Basins		35
Beakers		36
Funnels		37
Tissue Culture		
Cell Lifters & Scrapers		39
Cell Strainers		40
Microbiology		
Petri Dishes		42
Cell Spreaders		43
Inoculating Loops & Needles		44
Histology		
Microscope Slide Storage Boxes		46
Microscope Slides		47
Microscope Slide Mailers		48
Drosophila		
Drosophila Vials		50
Drosophila Bottles		51
Drosophila Plugs		52
Racks & Boxes		
Boxes		22-25
Racks		12, 26-28
Gloves		
Latex Gloves		55
Nitrile Gloves		55

Products Catalog Number Index

Cat #	Page#	Cat #	Page#	Cat #	Page#	Cat #	Page#
10-0151	8-9	51-17720	51	80-0500	10	93-0050	36
10-0152	8-9	51-17721	51	80-1500	10	93-0100	36
10-0501	8-9	51-0505	52	80-1501	10	93-0250	36
10-0502	8-9	51-0805	52	80-1502	10	93-0400	36
10-9151	8-9	51-17725	52	80-1503	10	93-0800	36
10-9152	8-9	60-0082	14-15	81-0053	20	93-1000	36
10-9501	8-9	60-0182	14-15	81-0054	20	97-1111	55
10-9502	8-9	60-0282	14-15	81-0153	20	97-1112	55
10-9815	8-9	60-0382	14-15	81-0154	20	97-1113	55
10-9850	8-9	60-0482	14-15	81-0203	20	97-1114	55
10-0815	8-9	60-0002	14-15	81-0204	20	97-1115	55
10-0850	8-9	60-0102	14-15	81-0000	20	97-6111	55
12-1275	11	60-0202	14-15	81-0001	20	97-6112	55
12-2275	11	60-0302	14-15	81-0002	20	97-6113	55
12-1300	11	60-0402	14-15	81-0003	20	97-6114	55
12-1299	11	60-0088	14-15	81-0004	20	97-6115	55
12-1399	11	60-0188	14-15	81-0005	20	99-1124	26-28
15-1040	40	60-0288	14-15	81-7053	21	99-1128	26-28
15-1070	40	60-0388	14-15	81-7054	21	99-1132	26-28
15-1100	40	60-0488	14-15	81-7153	21	99-1216	26-28
20-0010	30	60-0008	14-15	81-7154	21	99-1220	26-28
20-0200	30	60-0108	14-15	81-7203	21	99-1224	26-28
20-1000	30	60-0208	14-15	81-7204	21	99-2118	26-28
20-1250	30	60-0308	14-15	81-8204	21	99-2120	26-28
21-0010	30	60-0408	14-15	90-8009	12	99-2124	26-28
21-0200	30	60-0016	16	90-9009	24	99-2128	26-28
21-1000	30	60-0116	16	90-9081	25	99-2132	26-28
21-1250	30	60-0216	16	90-9100	25	99-2212	26-28
25-0051	35	60-0316	16	90-9200	25	99-2215	26-28
25-0052	35	60-0416	16	90-9210	24	99-2216	26-28
25-1025	35	60-0056	16	90-9250	24	99-2220	26-28
25-1100	35	60-0156	16	90-9025	25	99-2224	26-28
25-1202	35	60-0256	16	90-1100	22	99-2230	26-28
30-0135	34	60-0356	16	90-1281	22	99-5212	26-28
30-0135A1	34	60-0456	16	90-1200	22	99-5215	26-28
30-0138	34	66-1501	42	90-1381	22	99-5216	26-28
30-0138A1	34	66-1560	42	90-1300	22	99-5220	26-28
30-0238A1	34	66-1515	42	90-2281	22	99-6207	26-28
35-6050	37	65-0001	44	90-2200	22	99-6209	26-28
41-4020	48	65-0010	44	90-2381	22	99-6210	26-28
41-5025	46	65-0002	44	90-2300	22	99-6212	26-28
41-5100	46	65-1001	43	90-5281	22	99-6213	26-28
41-6025	46	65-1010	43	90-5200	22		
41-6100	46	70-1180	39	90-1536	12, 22		
51-0500	50	70-1250	39	90-5016	12, 22		
51-0501	50	70-2180	39	90-6100	23		
51-0800	50	7101	47	90-6281	23		
51-0801	50	7105	47	90-6200	23		

Sample Centrifugation and Concentration

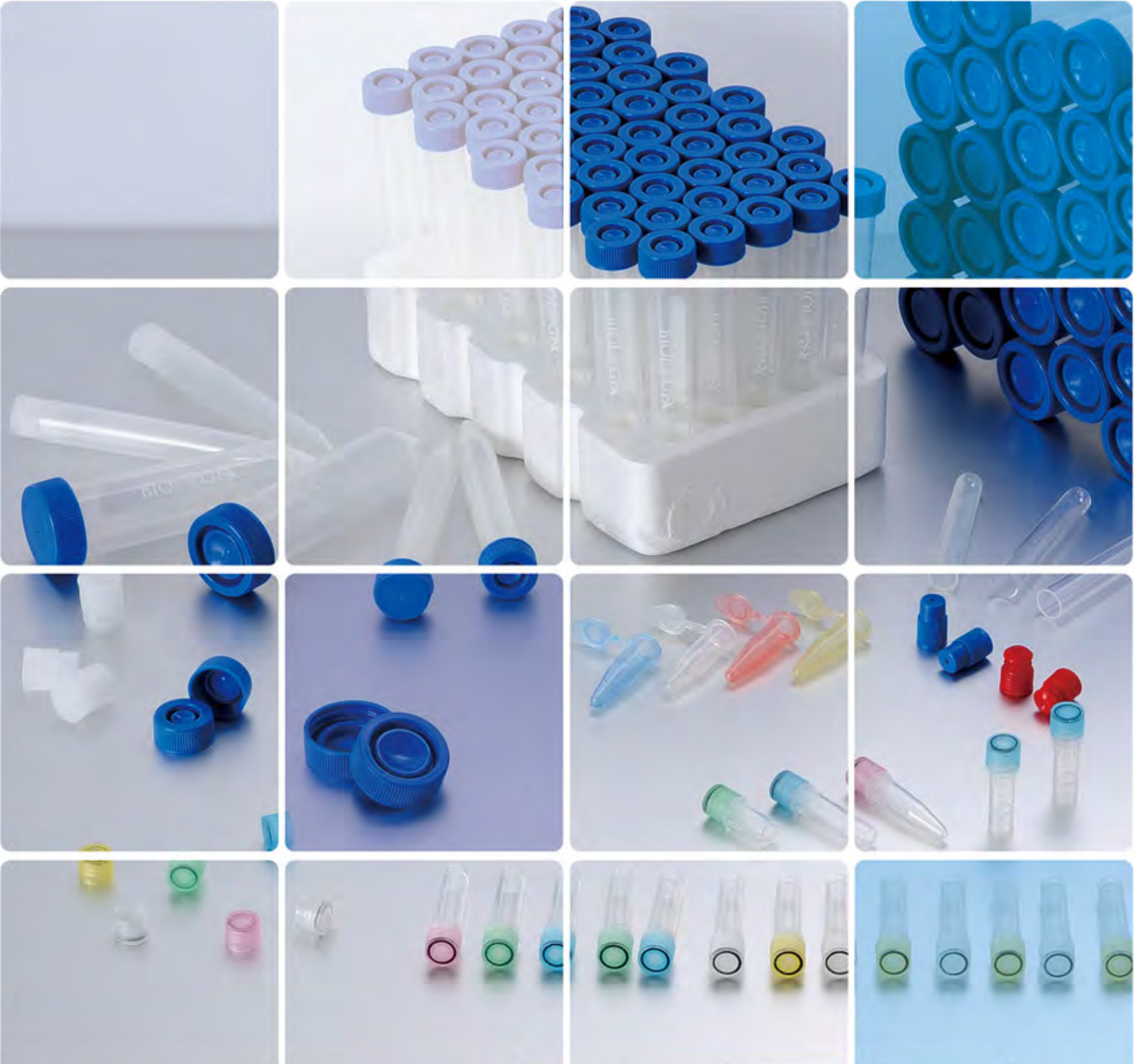

Centrifuge Tubes



FEATURES

- * Gamma radiation sterilized and non-sterilized available
- * Non-pyrogenic
- * 15ml and 50ml conical tubes available
- * Working temperature: stable from -20°C to 121°C
- * Withstand centrifugation of 8,400 RCF for 15ml and 9,400 RCF for 50ml in a fully supported rotor



Clear graduations provide an easy volume reference



Large white writing area for easy marking

Conical bottom for superior separation and pelleting



PACKAGING

1. Foam racked package (Sterile)
 - a) Foam racks offer the convenience of oriented product presentation
 - b) Samples can be viewed without removing tubes from rack
2. Bulk packed package (Sterile & Non-sterile)
 - a) Transparent polyethylene bags are durable and protect the tubes well
 - b) All sterile tubes are packaged with caps attached while non-sterile tubes are packaged with caps separately

*See Biologix Cell Strainers on page 40.

*See Biologix Funnels on page 37.

*See Biologix Tube Racks on page 12, 22.

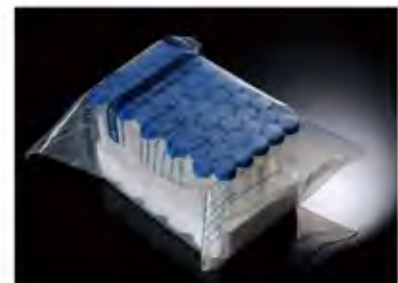

Note for Sterile Products: Contents sterile unless package is opened or damaged.

ORDERING INFORMATION



Cat #	Volume	Caps	Pack	Sterile	Unit
10-9151	15ml	Flat Top	Rack	Yes	50/rack, 500/case
10-9152	15ml	Flat Top	Bulk	Yes	50/bag, 500/case
10-9501	50ml	Flat Top	Rack	Yes	25/rack, 500/case
10-9502	50ml	Flat Top	Bulk	Yes	50/bag, 500/case
10-9815	15ml	Flat Top	Bulk	No	500/case
10-9850	50ml	Flat Top	Bulk	No	500/case
10-0151	15ml	Plug Seal	Rack	Yes	50/rack, 500/case
10-0152	15ml	Plug Seal	Bulk	Yes	50/bag, 500/case
10-0501	50ml	Plug Seal	Rack	Yes	25/rack, 500/case
10-0502	50ml	Plug Seal	Bulk	Yes	50/bag, 500/case
10-0815	15ml	Plug Seal	Bulk	No	500/case
10-0850	50ml	Plug Seal	Bulk	No	500/case

CAP DESIGN

1. Flat-top cap

- Biologically inert, high density polyethylene provides a chemically resistant surface
- Double threaded design to reduce cross-threading, easily opened and closed
- Flat top facilitates top writing areas for sample identification



PE flat-top cap
for labeling

2. Plug-seal screw on cap

- Biologically inert, high density polypropylene provides a chemically resistant surface
- Double threaded design to reduce cross-threading, easily opened and closed
- Autoclavable

PP plug-seal cap
is autoclavable



TUBE DESIGN

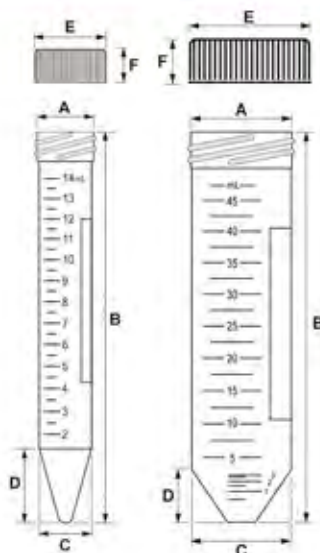

- * Tubes are made of strong, medical-grade polypropylene
- * Transparent wall permits easy viewing of tube contents
- * Conical bottom design fits most standard floor model and table-top centrifuges
- * Graduation with white ink, in 1ml (for 15ml Tubes) and 5ml (for 50ml Tubes) increments
- * White writing area facilitates sample identification
- * Solvent resistant printing will not rub off during routine laboratory procedures
- * Tubes are covered with leak-proof caps that comply with IATA Safety Standards

PRODUCT PARAMETER

Cat #	Description	Dimensions=mm					
		A	B	C	D	E	F
10-9152	Centrifuge Tube	O.D.17.5	119.6	O.D. 15.8	22.7	O.D. 22.0	10.3
10-9502	Centrifuge Tube	O.D.29.6	114.7	O.D. 29.2	15.6	O.D. 35.5	12.3

*See Biologix Cell Strainers on page 40.

*See Biologix Funnels on page 37.

*See Biologix Tube Racks on page 12, 22.

Microcentrifuge Tubes

FEATURES

- * Designed to withstand the stresses of high speed centrifugation of 23,000 RCF in a fully supported rotor
- * Made from high quality medical grade polypropylene
- * Transparent wall permits easy viewing of tube contents
- * Attached flat cap for labeling and with writing area on the side of the tube
- * RNase & DNase Free
- * Working temperature: stable from -20°C to 121°C (Autoclavable)
- * 4 attractive colors provide preference and identification of samples
- * Accurate graduation marks: 0.1ml, 0.5ml, 1.0ml and 1.5ml
- * Thumb-friendly beveled lip for easy one-hand operation



Flat cap for labeling

Frosted writing area for easy marking



Accurate graduations from 0.1 to 1.5ml provide an easy volume reference

Conical bottom for easy sample collection

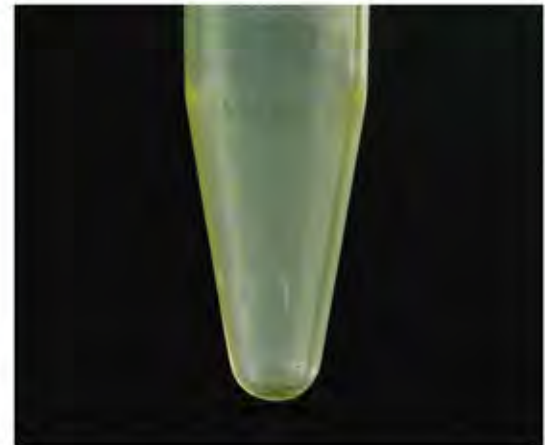

ORDERING INFORMATION

Cat #	Volume	Color	Sterile	Unit
80-1500	1.5ml	Clear	No	500/bag, 10 bags/case
80-1501	1.5ml	Red	No	500/bag, 10 bags/case
80-1502	1.5ml	Yellow	No	500/bag, 10 bags/case
80-1503	1.5ml	Blue	No	500/bag, 10 bags/case
80-0500	0.5ml	Clear	No	500/bag, 10 bags/case

Four colors for optimum sample visibility and organization



PRODUCT PARAMETER

Cat #	Description	Dimensions=mm				
		A	B	C	D	E
80-1500	Microcentrifuge Tube	O.D.13.0	O.D.10.8	39.3	O.D. 9.0	1.5

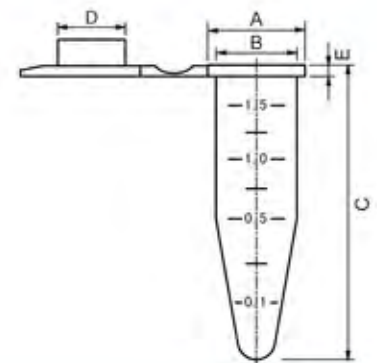

*See Biologix Microtube Racks on page 12, 22.

Test Tubes



FEATURES

- * Available with two sizes: 12 x 75mm and 13 x 100mm
- * Premium polystyrene tubes are clear like glass while Polypropylene tubes are durable and does not scratch easily
- * Round bottom fits most standard centrifugation machines
- * Caps are precision molded from low-density polyethylene and designed to fit firmly on the tubes
- * Working temperature: stable from -20°C to 60°C
- * Non-sterile, and tested to withstand centrifugation of 5,800 RCF
- * Clearly visible with either clear or turbid samples

ORDERING INFORMATION

Cat #	Description	Size(mm)	Material	Color	Volume	Sterile	Unit
12-1275	Tube	12x75	PS	Clear	5ml	No	500/bag, 2,000/case
12-2275	Tube	12x75	PP	Clear	5ml	No	500/bag, 2,000/case
12-1300	Tube	13x100	PS	Clear	8ml	No	250/bag, 2,000/case
12-1299	Cap	12x13.5	PE	Blue	-	No	1,000/bag, 2,000/case
12-1399	Cap	13x17.5	PE	Red	-	No	1,000/bag, 2,000/case

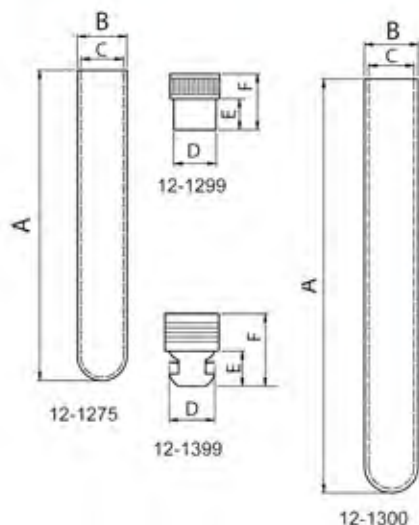

PRODUCT PARAMETER

Cat #	Description	Dimensions=mm					
		A	B	C	D	E	F
12-1275	Tube	75.0	O.D. 12.0	O.D. 10.3	-	-	-
12-1299	Cap	-	-	-	O.D. 10.3	7.5	13.5
12-1300	Tube	100.0	O.D. 13.0	O.D. 11.0	-	-	-
12-1399	Cap	-	-	-	O.D. 11.0	8.5	17.5

*See Biologix Liquid Handling products from page 29 to 37.

Tube Racks



Microtube Rack Design:

- * 80 wells and holds 1.5ml or 2.0ml microlubes
- * 5 assorted colors: blue, green, red, yellow, and purple

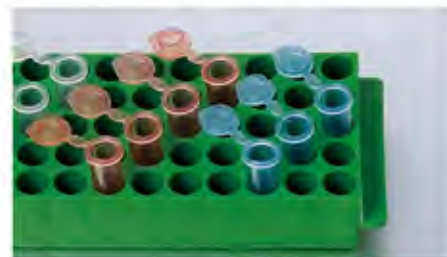

FEATURES

Microtube Racks:

- * Molded with a numeric grid for easy tube identification
- * Chemically resistant to alcohols and mild organic solvents
- * Each well is numbered for easy sample identification
- * Side handles for secure handling
- * Easily fill and transfer 80 tubes in compact arrangement (5 x 16 array)

Centrifuge Tube Racks:

- * Made from durable cardboard with superior white coating
- * Chemically resistant to alcohols and mild organic solvents
- * Temperature range: stable from -196°C to 121°C
- * Available with either 36-well or 16-well dividers
- * Holds 15ml or 50ml Centrifuge Tubes
- * Removable lid includes an inventory list writing area

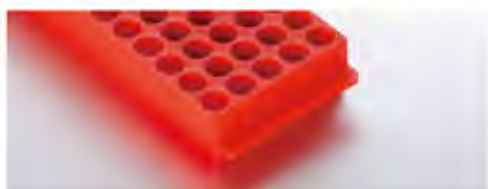

Side handles
for secure handling

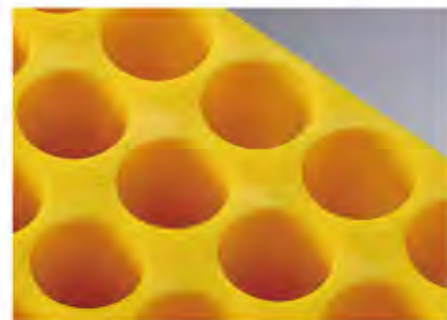

Molded with a numeric grid
for easy tube identification



Writing area on the side
of the rack for easy marking

ORDERING INFORMATION

Cat #	Color	Well	Sterile	Unit
90-8009	Assorted Colors	80-well	No	20 Racks/case
90-1536	White	36-well	No	100 Pieces/case
90-5016	White	16-well	No	100 Pieces/case

PRODUCT PARAMETER

Dimensions=mm

Cat #	Description	A	B	C	D	E	F	G
90-8009	Racks	209	27.2	26	O.D. 11.4	66	13	13

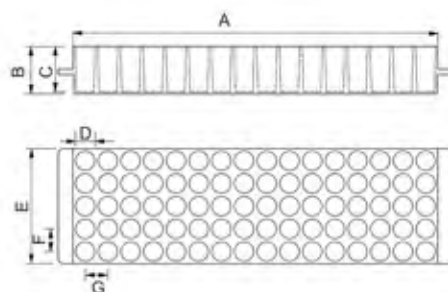

90-8009

- * See Biologix Microcentrifuge Tubes on page 10.
- * See Biologix Centrifuge Tubes from page 8 to 9.
- * See Biologix Racks and Boxes from page 53 to 54.

PCR

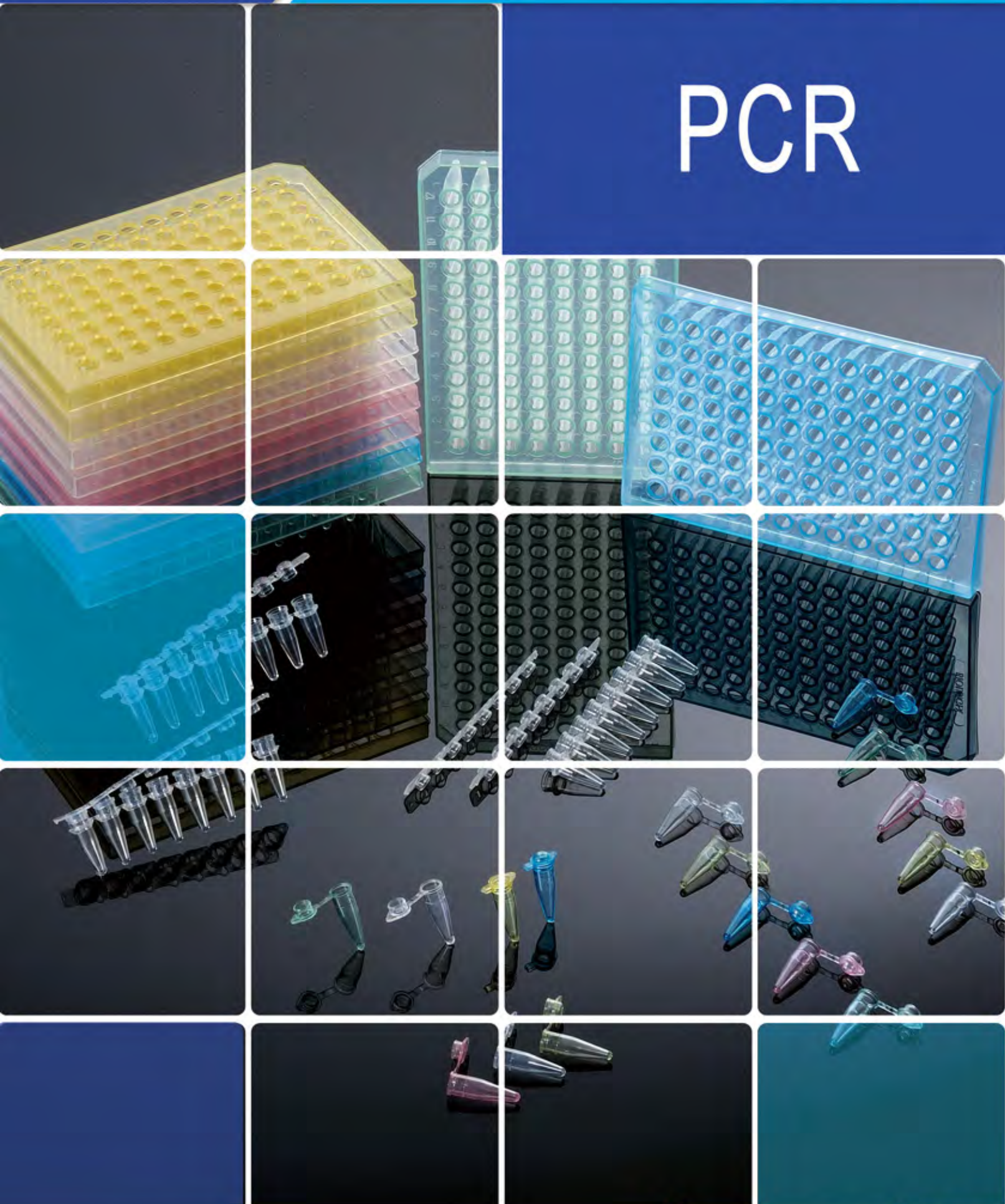

PCR Tubes



High degree of transparency

FEATURES

- * Manufactured from prime virgin polypropylene
- * Temperature range: stable from -20°C to 100°C
- * Tested to withstand centrifugation of 6,000 RCF in a fully supported rotor
- * Non-sterile
- * Autoclavable in open state
- * Certified RNase, DNase- and endotoxin-free on a lot by lot basis for highest sample integrity
- * Available in colors for optimum sample visibility and organization
- * Extra transparent caps allow for Real-Time PCR applications

Five colors for optimum sample visibility and organization



Optical flat cap strips feature ultra-clear upper surfaces, ideal for real-time PCR applications. They offer a light transmittance much higher than with standard strip caps. Made to seal tube strips and 96-well plates.

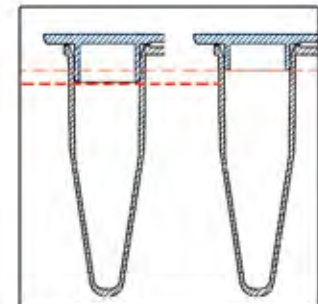

Longer cap flanges eliminate sample evaporation

PACKAGING

- * Shipped in re-sealable plastic bags packed in individual boxes – keeping them contamination-free and easily stored
- * 0.2ml single PCR tubes: 1,000 tubes/pack, 10 packs/case
- * 8 strip PCR tubes: strip caps and strip tubes are packed in separate re-sealable plastic bags. One bag of 125 tube strips (1,000 tubes) and one bag of 125 cap strips (1,000 caps) are packed in one cardboard package



ORDERING INFORMATION

Cat #	Volume	Color	Tube	Cap	Sterile	Unit
60-0082	0.2ml	Clear	Individual	Flat-top	No	1,000/pack, 10 Packs/case
60-0182	0.2ml	Pink	Individual	Flat-top	No	1,000/pack, 10 Packs/case
60-0282	0.2ml	Green	Individual	Flat-top	No	1,000/pack, 10 Packs/case
60-0382	0.2ml	Blue	Individual	Flat-top	No	1,000/pack, 10 Packs/case
60-0482	0.2 ml	Yellow	Individual	Flat-top	No	1,000/pack, 10 Packs/case
60-0002	0.2ml	Clear	Individual	Dome-shaped	No	1,000/pack, 10 Packs/case
60-0102	0.2ml	Pink	Individual	Dome-shaped	No	1,000/pack, 10 Packs/case
60-0202	0.2ml	Green	Individual	Dome-shaped	No	1,000/pack, 10 Packs/case
60-0302	0.2ml	Blue	Individual	Dome-shaped	No	1,000/pack, 10 Packs/case
60-0402	0.2ml	Yellow	Individual	Dome-shaped	No	1,000/pack, 10 Packs/case
60-0088	0.2ml	Clear	8-strip	Flat-top	No	125 Strip Tubes+125 Strip Caps/pack, 10 Packs/case
60-0188	0.2ml	Pink	8-strip	Flat-top	No	125 Strip Tubes+125 Strip Caps/pack, 10 Packs/case
60-0288	0.2ml	Green	8-strip	Flat-top	No	125 Strip Tubes+125 Strip Caps/pack, 10 Packs/case
60-0388	0.2ml	Blue	8-strip	Flat-top	No	125 Strip Tubes+125 Strip Caps/pack, 10 Packs/case
60-0488	0.2ml	Yellow	8-strip	Flat-top	No	125 Strip Tubes+125 Strip Caps/pack, 10 Packs/case
60-0008	0.2ml	Clear	8-strip	Dome-shaped	No	125 Strip Tubes+125 Strip Caps/pack, 10 Packs/case
60-0108	0.2ml	Pink	8-strip	Dome-shaped	No	125 Strip Tubes+125 Strip Caps/pack, 10 Packs/case
60-0208	0.2ml	Green	8-strip	Dome-shaped	No	125 Strip Tubes+125 Strip Caps/pack, 10 Packs/case
60-0308	0.2ml	Blue	8-strip	Dome-shaped	No	125 Strip Tubes+125 Strip Caps/pack, 10 Packs/case
60-0408	0.2ml	Yellow	8-strip	Dome-shaped	No	125 Strip Tubes+125 Strip Caps/pack, 10 Packs/case

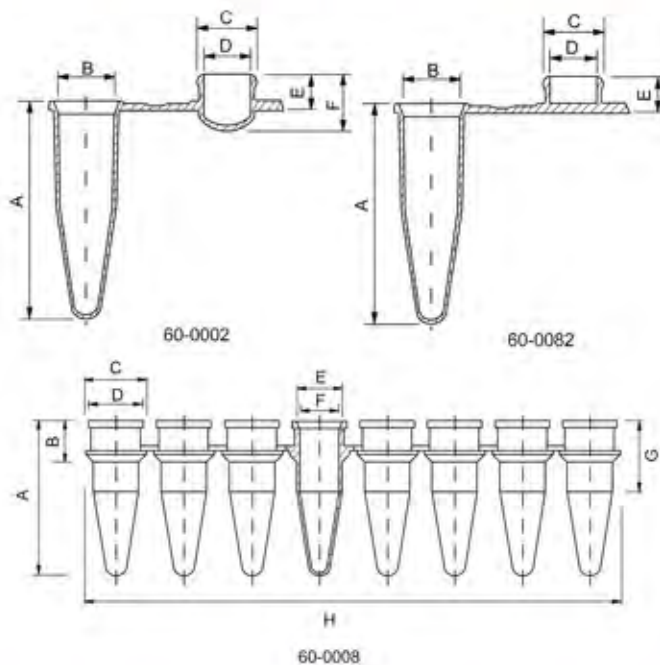

TUBES DESIGN

- * Ultra Thin-Wall Tubes provide faster heating and cooling than standard tubes, more efficient heat transfer, and shorter ramping times
- * Conical bottom design fits most of PCR machines

CAPS DESIGN



- * Available with domed caps for efficient heat transfer from cyclers lid or flat cap for easy piercing or labeling
- * Unique cap design eliminates popping during cycling and incubation stages
- * Ideal for Real-Time PCR (qPCR)

PRODUCT PARAMETER

Cat #	Description	Dimensions=mm					
		A	B	C	D	E	F
60-0082	Tube	20.75	O.D. 5.43	O.D. 5.54	O.D. 4.57	3.38	-
60-0002	Tube	20.75	O.D. 5.43	O.D. 5.54	O.D. 4.57	3.38	5.38
60-0008	Tube	20.70	3.40	O.D. 8.13	O.D. 7.11	O.D. 6.10	O.D.5.36
60-0088	Tube	20.70	3.40	O.D. 8.13	O.D. 7.11	O.D. 6.10	O.D.5.36

PCR Plates



FEATURES

- * Certified RNase & DNase and Endotoxin Free on a lot by lot basis for highest sample integrity
- * Temperature range: stable from -20°C to 100°C
- * Tested to withstand centrifugation of 6,000 RCF in a fully supported rotor
- * Compatible with most popular 96-well thermal cyclers
- * Made from 100% pure virgin polypropylene

PCR PLATES DESIGN

- * Ultra-thin walls of uniform thickness - accelerate heat transfer leading to shorter cycle times and more consistent results
- * Alphanumeric well coding to further assist in sample storage and organization
- * Clear well bottom for sample visibility
- * The half-skirted plate provides superior rigidity and is easy to insert and extract
- * The plate has a working volume of 0.2ml per well



Alphanumeric coding assist in sample organization



Half-skirted plate is easy to insert and extract



Non-skirted plate is convenient and easy to cut

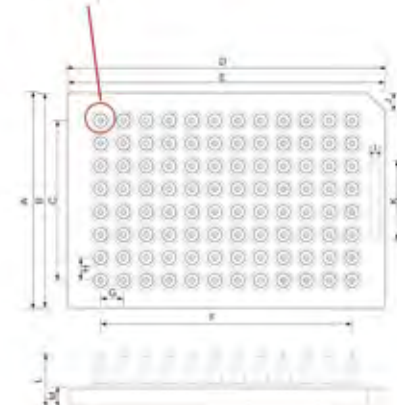
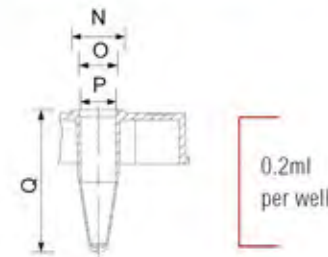

ORDERING INFORMATION

Cat #	Well	Skirt	Color	Sterile	Unit
60-0056	96-well	Half-Skirted	Clear	No	25/pack, 100/case
60-0156	96-well	Half-Skirted	Pink	No	25/pack, 100/case
60-0256	96-well	Half-Skirted	Green	No	25/pack, 100/case
60-0356	96-well	Half-Skirted	Blue	No	25/pack, 100/case
60-0456	96-well	Half-Skirted	Yellow	No	25/pack, 100 /case
60-0016	96-well	Non-Skirted	Clear	No	25/pack, 100/case
60-0116	96-well	Non-Skirted	Pink	No	25/pack, 100/case
60-0216	96-well	Non-Skirted	Green	No	25/pack, 100/case
60-0316	96-well	Non-Skirted	Blue	No	25/pack, 100/case
60-0416	96-well	Non-Skirted	Yellow	No	25/pack, 100 /case





PRODUCT PARAMETER

Cat #	Description	Dimensions=mm																
		A	B	C	D	E	F	G	H	I	J	K	L	M	N	O	P	Q
60-0056	PCR Plates	85.5	84.5	63	126	125	99	9	9	4	7	31	21	8	0.0.8	0.0.5.8	0.0.5.3	21

*See PCR Plates compatibility on page 17.

PCR Plates Compatibility

This chart is intended to be a general guide only. Your specific compatibility may vary based on your features installed and thus configuration. Contact us for further guidance on product selection.

Biologix Plates >		60-0056 (Half-Skirted)	60-0016 (Non-Skirted)	60-0056 (Half-Skirted)	60-0016 (Non-Skirted)
Brand	Model				
Real Time PCR Thermal Cyclers					
Applied Biosystems	7000	✓			
	7300	✓			
	7500	✓			
	7700	✓			
	7900HT	✓			
	StepOne				
BioRad	iCycler	✓	✓		
	Myi0		✓		
	i05	✓	✓		
Eppendorf	MasterCycler ep Realplex				
MJ Research	Opticon				
	Opticon 2				
	Chromo4				
Stratagene	MX-4000				
	MX-3000		✓		
Techne	Quantica				
PCR Thermal Cyclers					
Applied Biosystems	Veriti	✓	✓		
	9600	✓	✓		
	9700	✓	✓		
	9800 FAST				
	2720	✓	✓		
Biometra	Uno	✓	✓		
	Uno II	✓	✓		
	T1 Thermal Cycler	✓	✓		
	Tgradient	✓	✓		
	Trobot	✓	✓		
BioRad	iCycler	✓	✓		
	MyCycler	✓	✓		
Corbett Research	PalmCycler 96	✓			
	PalmCycler 384				
Eppendorf	Mastercycler	✓	✓		
	Mastercycler ep	✓	✓		
	Mastercycler M384				
Flexi	Gene	✓	✓		
	Genius	✓	✓		
Ericom	Single Block	✓	✓		
	TwinBlock	✓	✓		
	Deltacycler I	✓	✓		
ThermoHybaid	PCR Sprint	✓			
	PCR Express	✓	✓		
	Multiblock System	✓	✓		
	Touchdown	✓	✓		
	Omnigene	✓	✓		
	Omn-E	✓	✓		
	pxe	✓	✓		
	px2	✓	✓		
MJ Research	PTC-100	✓	✓		
	PTC-200	✓	✓		
	PTC-225 Tetrad	✓	✓		
	Dyad/Disciple	✓	✓		
MWG	Primus 96	✓	✓		
	Primus 384				
Stratagene	Robocycler		✓		
TaKaRa	TP240				
	TP3000	✓	✓		
Techne	Touchgene Gradient (TC512)	✓	✓		
	Genus (TC412)	✓	✓		
	Touchgene X	✓			
Sequencers					
Applied Biosystems	3100	✓	✓		
	3130	✓	✓		
	3700	✓	✓		
	3730/3730x	✓	✓		

FOR TECHNICAL INFORMATION, VISIT WWW.BIOLOGIXGROUP.COM

Cryogenic

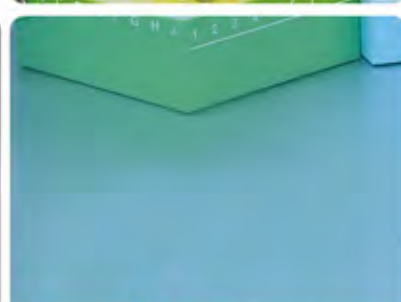



The **leader and complete solution provider**
in the Biorepository Kingdom

CryoKING Cryogenic Line

- Cryogenic Vials
- Cryogenic Combo
- Scanner & Software
- Cryogenic Boxes
- Freezer Racks
- BioBank Management Software

CryoKING means---

- The Ultimate Identification

- Pre-Set or custom Datamatrix 2D barcodes
- Scan Ready Design
- Never loose labels
- No need to take out tubes for identifications
- 5 seconds scan
- Total automation



- Always 10 x 10

to store 23% more samples
compared with 9 x 9 boxes

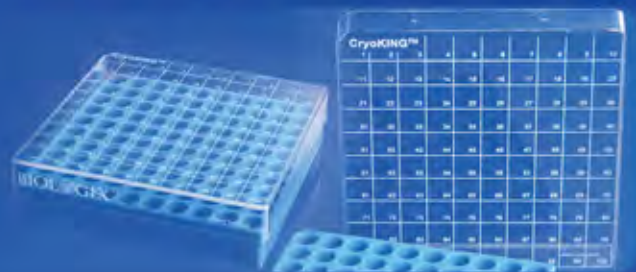

- One Inch Revolution

- Double Your Sample Storage with Half the Space and Cost**
- Improve sample security
- >70% Energy Savings
- Protect the environment and save our Earth



*For details, please refer to the **CryoKING catalogue** or www.CryoKING.com.

* The CryoKING® Cryogenic products are patent pending. CryoKING® is a registered trademark of Biologix Group Limited and its subsidiaries.

Screw Cap Microtubes



FEATURES

- * Ultimate in applications from sample storage in Ultra-low temperature freezer to boiling applications
- * Polypropylene material makes these screw cap tubes perfect for almost every long term storage application.
- * Superior clarity and phenomenal strength
- * Universal screw threads for use
- * Tubes fit most common rotors
- * Autoclavable to 121°C and freezable to -86°C
- * Tubes fit standard 1-inch and 2-inch, 81-well and 100-well freezer boxes

ORDERING INFORMATION

Cat #	Volume	Bottom	Color	Sterile	Unit
81-0053	0.5ml	Conical	Clear	No	500 Tubes/pack, 8 Packs/case
81-0054	0.5ml	Self-Standing	Clear	No	500 Tubes/pack, 8 Packs/case
81-0153	1.5ml	Conical	Clear	No	500 Tubes/pack, 8 Packs/case
81-0154	1.5ml	Self-Standing	Clear	No	500 Tubes/pack, 8 Packs/case
81-0203	2.0ml	Conical	Clear	No	500 Tubes/pack, 8 Packs/case
81-0204	2.0ml	Self-Standing	Clear	No	500 Tubes/pack, 8 Packs/case
81-0000	Caps	-	Clear	No	500 Caps/pack, 8 Packs/case
81-0001	Caps	-	Pink	No	500 Caps/pack, 8 Packs/case
81-0002	Caps	-	Green	No	500 Caps/pack, 8 Packs/case
81-0003	Caps	-	Blue	No	500 Caps/pack, 8 Packs/case
81-0004	Caps	-	Yellow	No	500 Caps/pack, 8 Packs/case
81-0005	Caps	-	Assorted	No	500 Caps/pack, 8 Packs/case

PRODUCT PARAMETER

Cat #	Description	Dimensions=mm				
		A	B	C	D	E
81-000(x)	Cap	9.7	O.D.12.6	O.D. 9.8	6.6	O.D. 7.4
81-0053	Tube	30.0	O.D. 9.6	O.D. 8.3	-	-
81-0054	Tube	31.0	O.D. 9.6	O.D. 8.3	30.6	O.D. 9.4
81-0153	Tube	46.5	O.D. 9.6	O.D. 8.3	-	-
81-0154	Tube	47.5	O.D. 9.6	O.D. 8.3	46.5	O.D. 9.4

*See our full line of Cryogenic Storage Boxes from page 22 to 25.

CAPS DESIGN

- * The O-Ring forms a perfect seal against the rim of each tube
- * Caps available in colors for optimum sample visibility and organization



O-Ring forms a perfect seal

Five colors for optimum sample visibility and organization

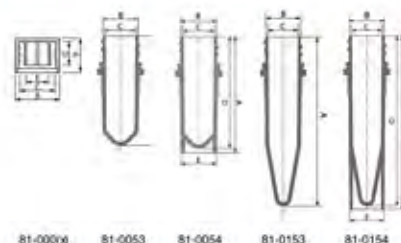

Cryogenic Vials



FEATURES

- * Ultimate in applications from sample storage in Ultra-low temperature freezer to boiling applications
- * Polypropylene material makes these screw cap tubes perfect for almost every long term storage application
- * Superior clarity and phenomenal strength
- * Universal screw threads for use
- * Tubes fit most common rotors
- * Autoclavable to 121°C and freezable to -86°C
- * Available in three sizes: 0.5ml, 1.5ml, and 2.0ml; and two formats: self-standing and conical
- * Tubes are screwed with caps and are gamma radiation sterilized
- * Tubes fit standard 1-inch and 2-inch, 81-well and 100-well freezer boxes

CAPS DESIGN

- * The O-Ring forms a perfect seal against the rim of each tube
- * Caps available in colors for optimum sample visibility and organization



Writing area for easy marking
Black graduations provide an easy volume reference

ORDERING INFORMATION

Cat #	Volume	Bottom	Writing Area	Sterile	Unit
81-7053	0.5ml	Conical	No	Yes	50 Sets/bag, 500 Sets/pack, 2000 Sets/case
81-7054	0.5ml	Self-Standing	No	Yes	50 Sets/bag, 500 Sets/pack, 2000 Sets/case
81-7153	1.5ml	Conical	No	Yes	50 Sets/bag, 500 Sets/pack, 2000 Sets/case
81-7154	1.5ml	Self-Standing	No	Yes	50 Sets/bag, 500 Sets/pack, 2000 Sets/case
81-7203	2.0ml	Conical	No	Yes	50 Sets/bag, 500 Sets/pack, 2000 Sets/case
81-7204	2.0ml	Self-Standing	No	Yes	50 Sets/bag, 500 Sets/pack, 2000 Sets/case
81-8204	2.0ml	Self-Standing	Yes	Yes	50 Sets/bag, 500 Sets/pack, 2000 Sets/case



Tubes with ribs lock in place enable single-handed operation

PRODUCT PARAMETER

Cat #	Description	Dimensions=mm				
		A	B	C	D	E
81-000(x)	Cap	9.7	O.D.12.6	O.D. 9.85	6.6	O.D. 7.39
81-7053	Tube	30.0	O.D. 9.6	O.D. 8.3	-	-
81-7054	Tube	31.0	O.D. 9.6	O.D. 8.3	30.6	O.D. 9.4
81-7153	Tube	46.5	O.D. 9.6	O.D. 8.3	-	-
81-7154	Tube	47.5	O.D. 9.6	O.D. 8.3	46.5	O.D. 9.4
81-7203	Tube	46.1	O.D. 9.6	O.D. 8.3	-	-
81-7204	Tube	47.5	O.D. 9.6	O.D. 8.3	46.5	O.D. 9.4

All sterilized Cryogenic Vials are packed with caps attached and include o-rings.

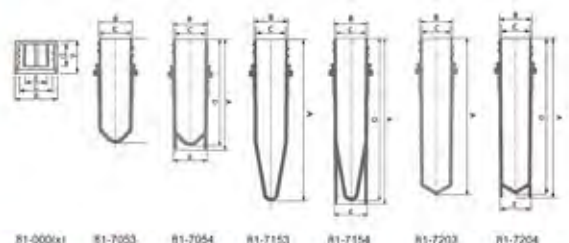

* See our full line of Cryogenic Storage Boxes from page 22 to 25.

Premium Cardboard Freezer Boxes

FEATURES

- * Made from durable cardboard with variety of outer coatings: (Superior white, Plasti-Coat™, or Cryo-Color™)
- * Chemically resistant to alcohols and mild organic solvents
- * Temperature range: stable from -196°C to 121°C
- * Suitable for liquid nitrogen storage



BOX DESIGN

- * Available in 1 inch, 2 inch, 3 inch sizes with either 81-well, 100-well, 36-well or 16-well dividers
- * Select from our Superior white coating, our Plasti-Coat™ laminated coating or our Cryo-Color™ boxes (Red, blue, yellow, and green)
- * Holds 0.5ml, 1.5ml or 2.0ml microtubes and 15ml, 50ml Centrifuge Tubes
- * Removable lid includes a frame box for labeling or writing



ORDERING INFORMATION

Cat #	Height	Well	Description	Color	Sterile	Unit
90-1100	1 in	100-well	Superior white	White	No	100 Pieces/case
90-1281	2 in	81-well	Superior white	White	No	100 Pieces/case
90-1200	2 in	100-well	Superior white	White	No	100 Pieces/case
90-1381	3 in	81-well	Superior white	White	No	100 Pieces/case
90-1300	3 in	100-well	Superior white	White	No	100 Pieces/case
90-1536	3 in	36-well	Superior white	White	No	100 Pieces/case
90-5016	3 in	16-well	Superior white	White	No	100 Pieces/case
90-2281	2 in	81-well	Plasti-Coat™	White	No	100 Pieces/case
90-2200	2 in	100-well	Plasti-Coat™	White	No	100 Pieces/case
90-2381	3 in	81-well	Plasti-Coat™	White	No	100 Pieces/case
90-2300	3 in	100-well	Plasti-Coat™	White	No	100 Pieces/case
90-5281	2 in	81-well	Cryo-Color™	Assorted Colors	No	100 Pieces/case
90-5200	2 in	100-well	Cryo-Color™	Assorted Colors	No	100 Pieces/case

PRODUCT PARAMETER

Cat #	Description	Dimensions=mm											
		A	B	C	D	E	F	G	H	I	J	K	L
90-1381	Superior white Box	130.0	127.0	15.0	15.0	74	73.5	30.0	34.0	32.5	133.0	131.0	76.0

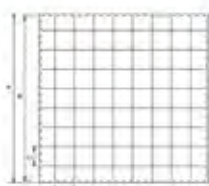

90-1381

Dimensions: 90-1100 : 133 x 133 x 39mm
90-1281 : 133 x 133 x 52mm

*See Biologix Cryogenic Vials from page 20 to 21.

*See Biologix Stainless Steel Freezer Racks from page 26 to 28.

ID-Color™ Cardboard Freezer Boxes

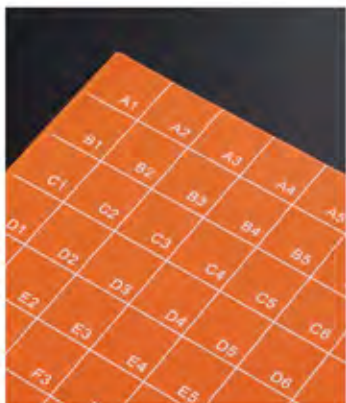

Alphanumeric grid for orientation



FEATURES



Hinged lid prevents misplace or loss

- * The lid, bottom, and four sides feature alphanumeric identifications for fast, easy, and error-free identification of individual samples
- * 5 attractive colors provide preference and identification of samples
- * Water resistant ID-Color™ coating allows for improved durability
- * Hinged lid prevents accidental misplace or loss
- * Sturdy and straight plastic dividers withstand ultra low temperatures
- * Holds 0.5ml/1.5ml/2.0ml microtubes and cryogenic vials



Sturdy and straight plastic dividers withstand ultra low temperature

ORDERING INFORMATION

Cat #	Height	Well	Divider Material	Unit
90-6281	2 in	81-well	PP	20 Pieces/case
90-6200	2 in	100-well	ABS	20 Pieces/case
90-6100	1 in	100-well	ABS	20 Preces/case

PRODUCT PARAMETER

Dimensions=mm

Cat #	Description	A	B	C	D	E	F	G	H	I	J	K	L
90-6281	Box	128.6	125	12.5	12.5	51.8	50.0	34.2	26.4	24.6	134.8	131.2	48.2



For error-free identification

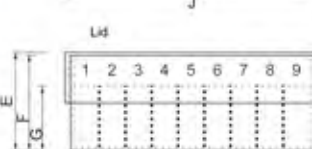
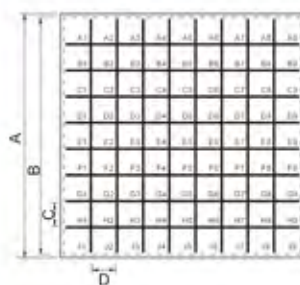

90-6281

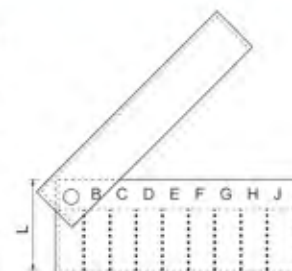

*See Biologix Cryogenic Vials from page 20 to 21.

*See Biologix Stainless Steel Freezer Racks from page 26 to 28.

PC Freezer Boxes

FEATURES

- * For easy inventory management of cryogenic vials used in tissue culture, pharmaceutical research and other biotechnology labs
- * Store in mechanical freezers or liquid nitrogen
- * Boxes are vented, allowing rapid cooling of contents and full drainage
- * Made of tough polycarbonate for use with temperatures from -196°C to 121°C
- * Chemically resistant to alcohols and mild organic solvents

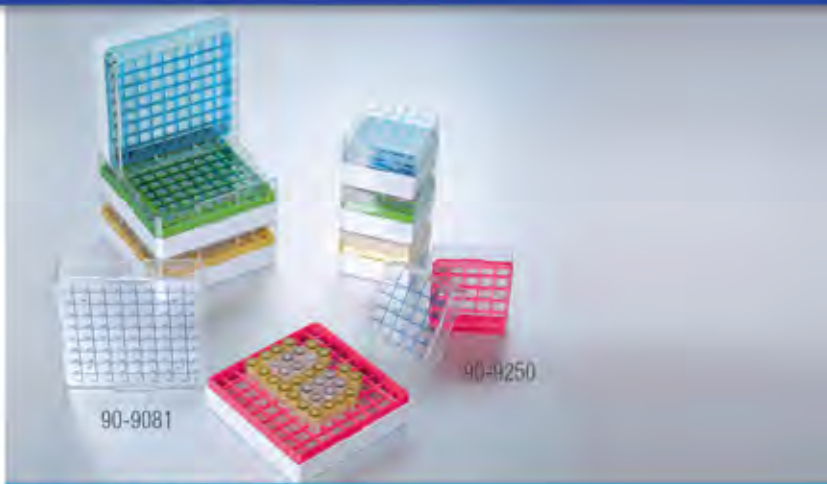
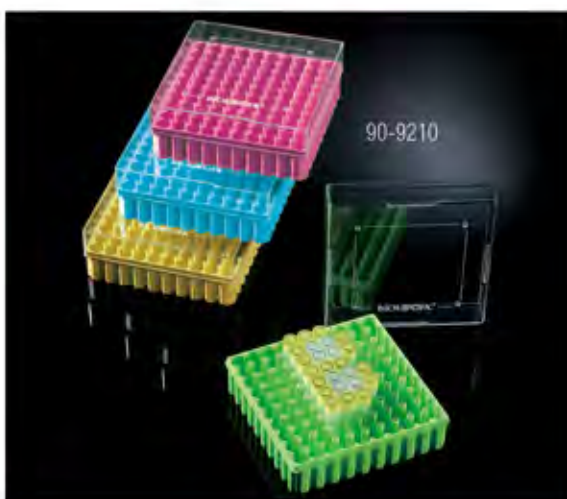

BOX DESIGN

- * 9x9 well storage (81-well total) or 10x10 well storage (100-well total) or 5x5 well storage (25-well total)
- * Boxes are designed with international standard size, which can fit all of the standard cryogenic vials and freezer racks
- * With 4 assorted colors: red, yellow, green, and blue for better color-coding
- * Holds 0.5ml, 1.5ml or 2.0ml microtubes and cryogenic vials
- * 81-well and 25-well box features a removable lid includes a numbered grid for orientation
- * 100-well box with numeric identification on each column for quick sample identification

ORDERING INFORMATION

Cat #	Well	Material	Color	Sterile	Unit
90-9210	100-well	PC	Assorted Colors	No	24 Boxes/case
90-9009	81-well	PC	Assorted Colors	No	24 Boxes/case
90-9250	25-well	PC	Assorted Colors	No	24 Boxes/case

PRODUCT PARAMETER

Cat #	Description	Dimensions=mm						
		A	B	C	D	E	F	G
90-9009	Box	132.0	12.2	35.0	30.0	26.0	16.5	132.0
90-9009C	Lid	132.0	132.0	26.0	-	-	-	-



Numbered grid for sample identification



Easy for sample organization

*See Biologix Cryogenic Vials from page 20 to 21.

*See Biologix Stainless Steel Freezer Racks from page 26 to 28.

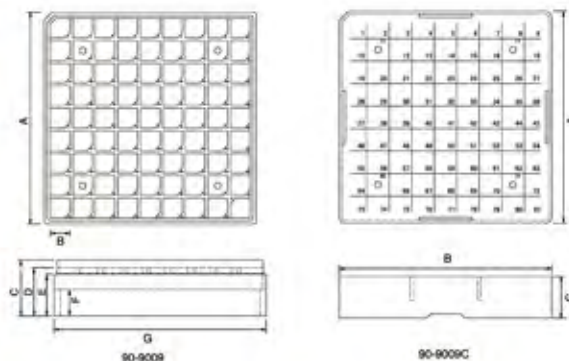

Dimensions: 90-9250 : 75 x 75 x 52mm
90-9210 : 132 x 132 x 53mm

You can put your logo here



Each box includes drain holes and air vents in the lid and bottom to minimize condensation

PP Freezer Boxes

FEATURES

- * For easy inventory management of cryogenic vials used in tissue culture, pharmaceutical research and other biotechnology labs
- * Boxes except 90-9100 are designed with international standard size, which can fit all of the standard cryogenic vials and freezer racks.
- * Store in mechanical freezers
- * Boxes are vented, allowing rapid cooling of contents and full drainage
- * Made of polypropylene for use with temperature from -86°C to 121°C
- * Chemically resistant to alcohols and mild organic solvents

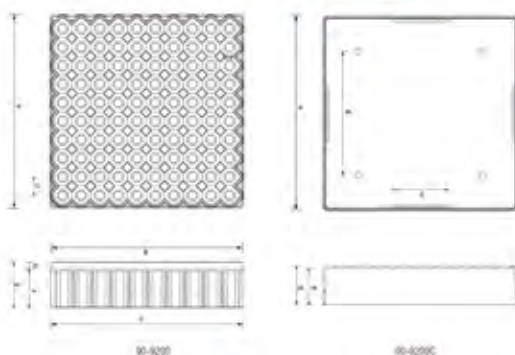

Dimensions: 90-9081 : 132 x 132 x 53mm
90-9100 : 141.0 x 153.7 x 54.6mm

Numbered grid for orientation



You can put your logo here

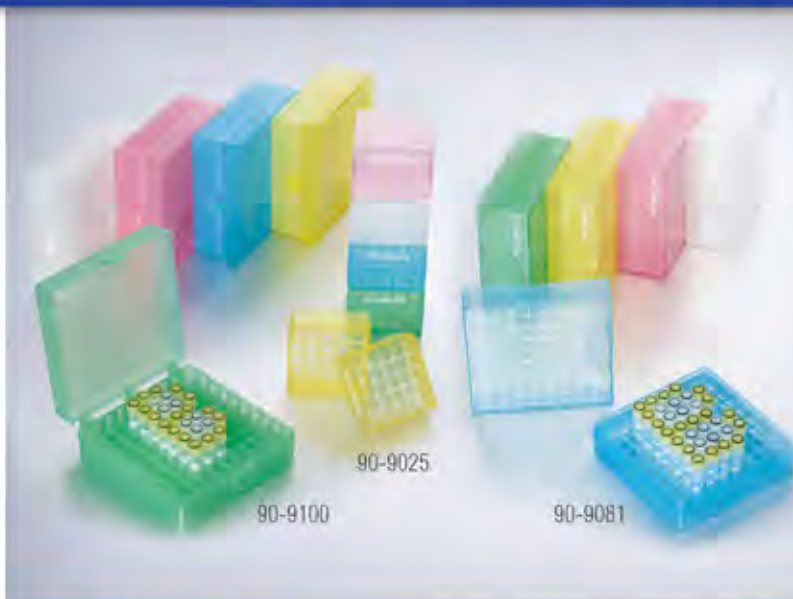

BOX DESIGN

- * 9x9 well storage (81-well total) or 10x10 well storage (100-well total) or 5x5 well storage (25-well total)
- * With 5 assorted colors: clear, pink, green, blue, and yellow for better color-coding
- * Holds 0.5ml, 1.5ml or 2.0ml microtubes and cryogenic vials
- * 81-well and 25-well box features a removable lid includes a numbered grid for orientation
- * 90-9100 box features a 3-hinged lid with alphanumeric grid for orientation
- * 90-9200 box with numeric identification on each column for quick sample identification

ORDERING INFORMATION

Cat #	Well	Material	Color	Sterile	Unit
90-9100	100-well	PP	Assorted Colors	No	20 Boxes/case
90-9200	100-well	PP	Assorted Colors	No	20 Boxes/case
90-9081	81-well	PP	Assorted Colors	No	20 Boxes/case
90-9025	25-well	PP	Assorted Colors	No	20 Boxes/case

PRODUCT PARAMETER

Cat #	Description	Dimensions=mm						
		A	B	C	D	E	F	G
90-9200	Box	132	129.7	130.7	12.6	31.3	26.4	4.9
90-9200C	Lid	132.5	84.7	38.4	26.7	25.0	-	-

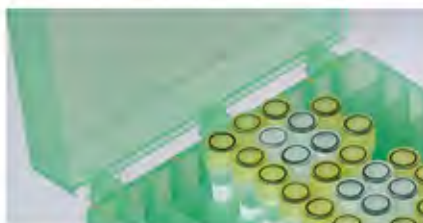

3-hinged lid prevents misplace or loss



Easy for sample organization

*See Biologix Cryogenic Vials from page 20 to 21.

*See Biologix Stainless Steel Freezer Racks from page 26 to 28.

Stainless Steel Freezer Racks

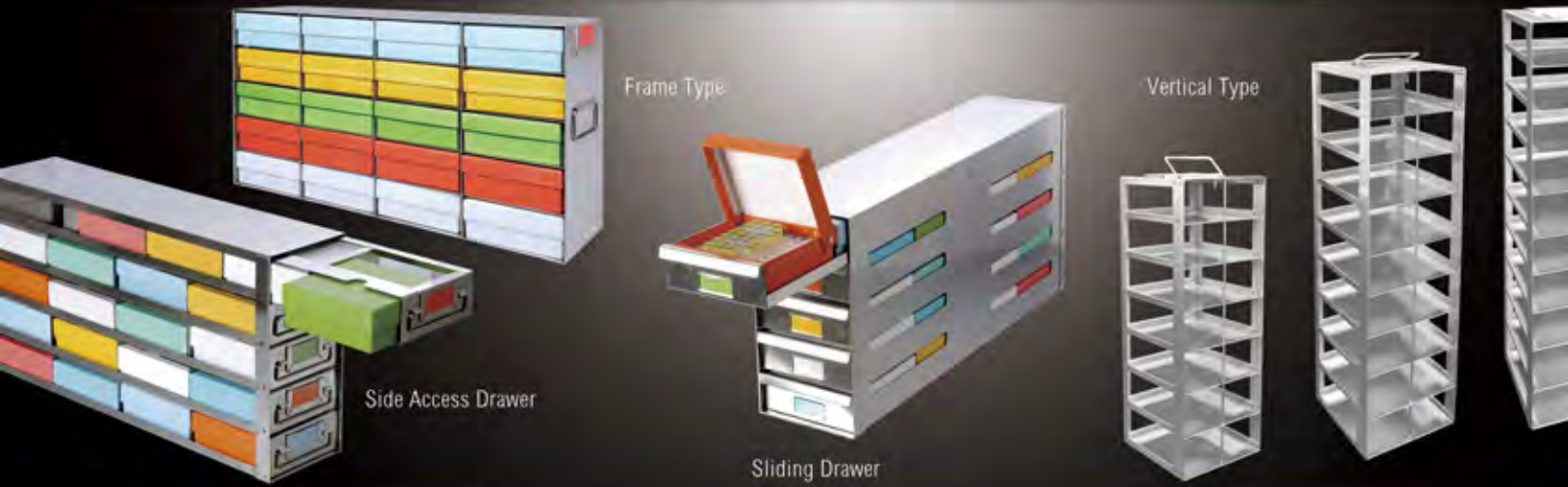

FEATURES

- * Fully functional Freezer Rack is constructed of corrosion-resistant stainless steel
- * Sliding Drawer Freezer Racks include handles for easy removal off the shelf
- * Optimize Freezer Storage Space
- * Ideal for storage of 2" and 1" standard size boxes
- * Fits most standard upright freezers
- * Available with Sliding Drawer, Frame Type and Vertical Type Freezer Racks

Sliding Drawer Freezer Racks
Patent No.: 201120501928. X



RACKS DESIGN



Handles for easy removal off the shelf
Colored labels for drawer/sample identification

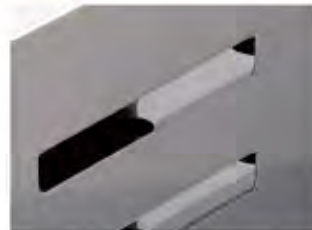

Flanging design reduces scratch



Folded rails to reduce frost

Fits most freezers
and optimize storage space



*See our full line of Cryogenic Storage Boxes from page 22 to 25.

*See our full line of Cryogenic Vials from page 20 to 21.

ORDERING INFORMATION

Cat #	Description	Dimension(mm) (D x W x H)	Capacity (D x H Configuration)	Storage box size(mm)
99-1224	Sliding Drawer	564*141*341	4*6	133*133*52
99-1220	Sliding Drawer	564*141*285	4*5	133*133*52
99-1216	Sliding Drawer	564*141*229	4*4	133*133*52
99-5220	Side Access Drawer	560*140*300	4*5	133*133*52
99-5216	Side Access Drawer	560*140*240	4*4	133*133*52
99-5215	Side Access Drawer	420*140*300	3*5	133*133*52
99-5212	Side Access Drawer	420*140*240	3*4	133*133*52
99-2230	Frame Type	700*137*339	5*6	133*133*52
99-2224	Frame Type	560*137*339	4*6	133*133*52
99-2220	Frame Type	560*137*284	4*5	133*133*52
99-2216	Frame Type	560*137*229	4*4	133*133*52
99-2215	Frame Type	422*137*284	3*5	133*133*52
99-2212	Frame Type	422*137*229	3*4	133*133*52
99-1132	Sliding Drawer	564*141*325	4*8	133*133*36
99-1128	Sliding Drawer	564*141*285	4*7	133*133*36
99-1124	Sliding Drawer	564*141*245	4*6	133*133*36
99-2132	Frame Type	560*137*315	4*8	133*133*36
99-2128	Frame Type	560*137*284	4*7	133*133*36
99-2124	Frame Type	560*137*244	4*6	133*133*36
99-2120	Frame Type	560*137*204	4*5	133*133*36
99-2121	Frame Type	560*137*284	3*7	133*133*36
99-2118	Frame Type	560*137*244	3*6	133*133*36
99-6207	Vertical Type	140*140*394	1*7	133*133*52
99-6209	Vertical Type	140*140*506	1*9	133*133*52
99-6210	Vertical Type	140*140*562	1*10	133*133*52
99-6212	Vertical Type	140*140*674	1*12	133*133*52
99-6213	Vertical Type	140*140*730	1*13	133*133*52

PRODUCT PARAMETER

Cat #	Description	Dimensions=mm									
		A	B	C	D	E	F	G	H	I	J
99-1220	Racks	564	140	282	180	180	545	44	52.1	55.8	136

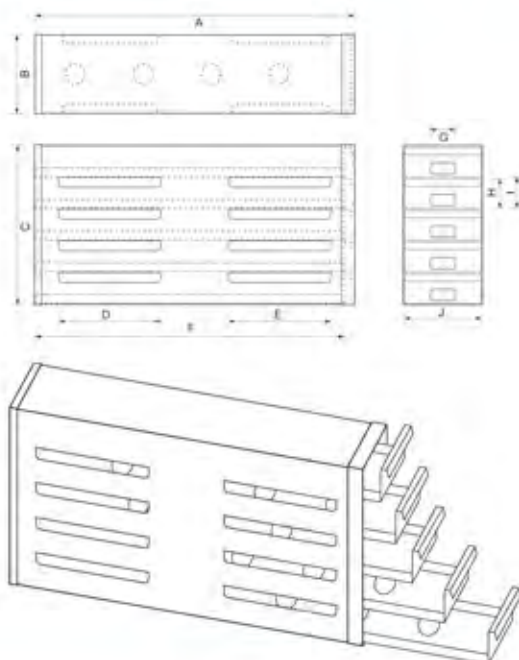

Patent No:
201120501928. X

*See our full line of Cryogenic Storage Boxes from page 22 to 25.
*See our full line of Cryogenic Vials from page 20 to 21.

Common Freezer Matching Table

Freezer Brand / Cat #	Location	2-Inch Plan				1-Inch Plan			
		Racks Cat#	Q'ty of Racks	Q'ty of Boxes	Q'ty of Samples 9*9 box or 10*10 box	Racks Cat#	Q'ty of Racks	Q'ty of Boxes	Q'ty of Samples 10*10 box
THERMO 907	Total Chambers	99-1220	24	480	38880 / 48000	99-2128	24	672	67200
		Or				Or			
		99-5220	24	480	38880 / 48000	99-1128	24	672	67200
		Or							
		99-2220	24	480	38880 / 48000				
THERMO 705	Total Chambers	99-1220	16	320	25920 / 32000	99-2128	16	448	44800
		Or				Or			
		99-5220	16	320	25920 / 32000	99-1128	16	448	44800
		Or							
		99-2220	16	320	25920 / 32000				
PANASONIC MDF-U53V	Upper Two Chambers	99-1224	8	192	15552 / 19200	99-1132	8	256	25600
		Or				Or			
	Lower Two Chambers	99-2224	8	192	15552 / 19200	99-2132	8	256	25600
		Or				Or			
		99-1220	8	160	12960 / 16000	99-1128	8	224	22400
PANASONIC MDF-U73V	Upper Two Chambers	99-2220	8	160	12960 / 16000	99-2128	8	224	22400
		Or				Or			
	Lower Two Chambers	99-1224	12	288	23328 / 28800	99-1132	24	768	76800
		Or				Or			
		99-2224	12	288	23328 / 28800	99-2132	24	768	76800
HAIER DW-86L628	Total Chambers	99-2220	20	400	32400 / 40000	99-1132	24	768	76800
		Or				Or			
	Total Chambers	99-1220	20	400	32400 / 40000	99-1128	20	560	56000
		Or				Or			
HAIER DW-86L728	Total Chambers	99-2220	20	400	32400 / 40000	99-2128	20	560	56000
		Or				Or			
	Total Chambers	99-1220	24	480	38880 / 48000	99-2128	24	672	67200
		Or				Or			
		99-2220	24	480	38880 / 48000	99-1128	24	672	67200
EPPENDORF U410	Total Chambers	99-1216	15	240	19440 / 24000	99-1124	15	360	36000
		Or				Or			
		99-5216	15	240	19440 / 24000	99-2124	15	360	36000
		Or							
		99-2216	15	240	19440 / 24000				
EPPENDORF U570	Total Chambers	99-1216	25	400	32400 / 40000	99-1124	25	600	60000
		Or				Or			
		99-5216	25	400	32400 / 40000	99-2124	25	600	60000
		Or							
		99-2216	25	400	32400 / 40000				

*See our full line of Cryogenic Storage Boxes from page 22 to 25.

*See our full line of Cryogenic Vials from page 20 to 21.

Liquid Handling



Pipet Tips



Snap fastener

FEATURES

- * Available in 10µl, 200µl and 1000µl pipet tips
- * 10µl and 200µl tips are graduated, easy to visually check the volume pipetted
- * Made from polypropylene
- * 200µl tips with beveled point design reduces sample retention
- * Durable and attractive racks can be repeatedly used
- * Special design reduces sample loss and save costly reagents
- * Autoclavable
- * RNase & DNase Free
- * Available sterile & non-sterile
- * Universal fit to most pipettors
- * 100% inert
- * Different volume with different color for identification of samples
- * Fast and effective analyte transport

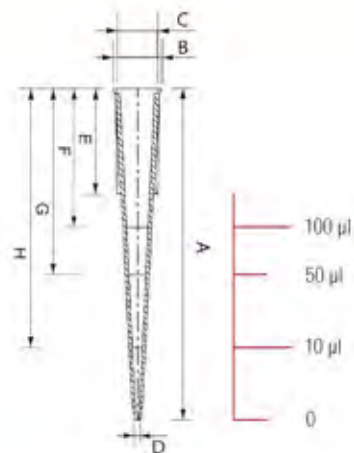

Graduated to allow for visual checking of volume draw

ORDERING INFORMATION

Cat #	Volume	Color	Sterile	Unit
20-0010	10µl	Natural	No	1,000 Tips/bag, 10 Bags/case
20-0200	200µl	Yellow	No	1,000 Tips/bag, 10 Bags/case
20-1000	1000µl	Blue	No	1,000 Tips/bag, 10 Bags/case
20-1250	1000µl	Natural	No	1,000 Tips/bag, 6 Bags/case
21-0010	10µl	Natural	Yes	96 Tips/rack, 100 Racks/case
21-0200	200µl	Yellow	Yes	96 Tips/rack, 100 Racks/case
21-1000	1000µl	Blue	Yes	100 Tips/rack, 60 Racks/case
21-1250	1000µl	Natural	Yes	100 Tips/rack, 60 Racks/case

PRODUCT PARAMETER

Cat #	Description	Dimensions=mm							
		A	B	C	D	E	F	G	H
20-0200	Pipet Tip	50.5	O.D. 7.5	O.D. 6.1	O.D. 0.9	16.1	21.2	28.4	39.5

With hinged lids



*See Pipet Tips compatibility from page 31 to 33.

*See Biologix Solution Basins on page 35.



Pipet Tips Compatibility

Pipettor Brand/make	Volume Range	Volume/Biologix Tip									
		0.5-10µl	0.5-10µl	20-200µl	21-200µl	20-200µl	21-200µl	20-1000µl	21-1000µl		
Axygen Axyjet (single channel)	0.1-2µl	✓	✓								
	0.5-10µl	✓	✓								
	2-20µl			✓	✓						
	5-50µl			✓	✓						
	10-100µl			✓	✓						
	20-200µl			✓	✓						
	50-250µl										
	100-1000µl					✓	✓	✓	✓		
	(multi-channel)	1-10µl	✓	✓							
		5-50µl			✓	✓					
20-200µl				✓	✓						
50-300µl				✓	✓						
Axygen Axyjet-16	0.2-2µl										
	0.5-10µl										
	5-50µl										
Biohit Proline (single channel)	0.2-10µl	✓	✓								
	5-100µl			✓	✓						
	10-250µl			✓	✓						
	10-500µl					✓	✓	✓	✓		
	50-1000µl					✓	✓	✓	✓		
(multi-channel)	0.2-10µl	✓	✓								
	5-100µl			✓	✓						
	25-250µl			✓	✓						
Biohit e-Line (single channel)	0.2-10µl	✓	✓								
	5-120µl			✓	✓						
	10-300µl			✓	✓						
	50-1000µl					✓	✓	✓	✓		
(multi-channel)	0.2-10µl	✓	✓								
	5-120µl			✓	✓						
	10-300µl			✓	✓						
Biohit m-Line (s/ch)	0.5-10µl										
	2-20µl			✓	✓						
	10-100µl			✓	✓						
Biohit m-Line (single) (multi-ch)	20-200µl			✓	✓						
	100-1000µl					✓	✓	✓	✓		
	0.5-10µl	✓	✓								
	5-100µl			✓	✓						
	30-300µl			✓	✓						
	Capp Aero (single/ multi-channel)	0.2-2µl	✓	✓							
		0.5-10µl	✓	✓							
		5-50µl			✓	✓					
		10-100µl			✓	✓					
		25-200µl			✓	✓					
(384 format multi-channel)	50-300µl			✓	✓						
	100-1000µl					✓	✓	✓	✓		
	0.2-2µl										
	0.5-10µl										
BrandTech Transferpette (single channel)	5-50µl										
	10-100µl			✓	✓						
	20-200µl			✓	✓						
BrandTech Transferpette (multi-channel)	25-250µl			✓	✓						
	100-1000µl					✓	✓	✓	✓		
	0.5-10µl	✓	✓								
	2-20µl			✓	✓						
Eppendorf Electronic	2.5-25µl			✓	✓						
	5-50µl			✓	✓						
	10-100µl			✓	✓						
	20-200µl			✓	✓						
Eppendorf Electronic	30-300µl			✓	✓						
	50-1000µl					✓	✓	✓	✓		
	0.5-10µl	✓	✓								
	5-100µl			✓	✓						

FOR TECHNICAL INFORMATION, VISIT WWW.BIOLOGIXGROUP.COM

Volume Range
Volume/Biologix Tip
Pipettor Brand/Make



Volume Range	100-1000µl	20-1250	100-1000µl	20-1000	1-200µl	20-0200	0.5-10µl	20-0200	0.5-10µl	21-0010	20-0010	Volume/Biologix Tip	Pipettor Brand/Make
0.1-2µl											✓	✓	
0.5-10µl											✓	✓	
2-20µl							✓	✓					Labnet Labpette (single channel)
10-100µl							✓	✓					
20-200µl							✓	✓					
100-1000µl	✓	✓	✓	✓									
1-10µl											✓	✓	
5-50µl							✓	✓					Labnet Labpette (multi-channel)
20-200µl							✓	✓					
50-300µl							✓	✓					
0.5-10µl											✓	✓	
2-20µl											✓	✓	Labnet BioPette E (single channel)
10-200µl							✓	✓					
100-1000µl	✓	✓	✓	✓									
0.5-10µl											✓	✓	
2-20µl											✓	✓	Labnet BioPette E (multi-channel)
10-200µl							✓	✓					
100-1200µl	✓	✓	✓	✓									
2-125µl							✓	✓					
5-250µl													MatrixImpact/ Impact ² (s/mc)
15-1250µl													
0.5-10µl											✓	✓	
2-20µl							✓	✓					
10-50µl							✓	✓					Nichiryo/Oxford Benchmate
10-100µl													
20-200µl													
100-1000µl													
E-MIC-10,0.5-10µl											✓	✓	
E2-25,2.5-25µl							✓	✓					Rainin EDP3 (single channel)
E2-100,10-100µl							✓	✓					
E2-250,25-250µl							✓	✓					
E2-1000,100-1000µl	✓	✓	✓	✓									

Volume Range
Volume/Biologix Tip
Pipettor Brand/Make



Volume Range	100-1000µl	20-1250	100-1000µl	20-1000	1-200µl	20-0200	0.5-10µl	20-0200	0.5-10µl	21-0010	20-0010	Volume/Biologix Tip	Pipettor Brand/Make
0.1-10µl											✓	✓	
2-20µl													
10-100µl							✓	✓					Eppendorf Reference
20-200µl							✓	✓					
100-1000µl							✓	✓					
0.1-2.5µl	✓	✓	✓	✓							✓	✓	
0.5-10µl											✓	✓	
2-20µl							✓	✓					Eppendorf Research (single channel)
10-100µl							✓	✓					
20-200µl							✓	✓					
100-1000µl	✓	✓	✓	✓									
0.5-10µl											✓	✓	
5-100µl													
50-100µl							✓	✓					Eppendorf (multi-channel)
20-300µl							✓	✓					
30-300µl							✓	✓					
50-1200µl	✓	✓	✓	✓	✓	✓	✓	✓					
0.2-10µl											✓	✓	
0.5-10µl											✓	✓	ThermoLabSystems Finnpiquette (single channel)
5-40µl							✓	✓					
40-200µl							✓	✓					
100-1000µl	✓	✓	✓	✓									
200-1000µl	✓	✓	✓	✓									
5-50µl							✓	✓					(multi-channel)
50-300µl							✓	✓					
P2, 0.1-2µl											✓	✓	
P10, 0.2-10µl											✓	✓	
P20, 2-20µl							✓	✓					Gilson Pipetman (single channel)
P100, 10-100µl							✓	✓					
P200, 20-200µl							✓	✓					
P1000, 100-1000µl	✓	✓	✓	✓									
P200-M8, 20-200µl							✓	✓					(m/ch)

FOR TECHNICAL INFORMATION, VISIT WWW.BIOLOGIXGROUP.COM

Pipet Tips Compatibility

Pipettor Brand/make		Volume Range Volume/Biologix Tip							
		0.5-10µl	0.5-10µl	20-0010	21-0010	20-0200	21-0200	20-1000	21-1000
		1-200µl	1-200µl	100-1000µl	100-1000µl	100-1000µl	20-1250	21-1250	
Rainin EDP3 (multichannel)	EP-M8-10,0.5-10µl	✓	✓						
	EP-M8-250,10-250µl			✓	✓				
	R2,0.1-2µl	✓	✓						
	R10,0.2-10µl	✓	✓						
Rainin Latch Mode	R20,2-20µl			✓	✓				
	R100,10-100µl			✓	✓				
	R200,20-200µl			✓	✓				
	R1000,100-1000µl					✓	✓	✓	✓
Socorex Calibra/Accura (single channel)	0.1-2µl	✓	✓						
	0.2-2µl	✓	✓						
	0.5-10µl	✓	✓						
	1-10µl	✓	✓						
	2-20µl			✓	✓				
(multichannel)	10-100µl			✓	✓				
	20-200µl			✓	✓				
	100-1000µl					✓	✓	✓	✓
	50-200µl			✓	✓				
(multichannel)	1-10µl	✓	✓						
	5-50µl			✓	✓				
	10-100µl			✓	✓				
	20-200µl			✓	✓				

Pipettor Brand/make		Volume Range Volume/Biologix Tip							
		0.5-10µl	0.5-10µl	20-0010	21-0010	20-0200	21-0200	20-1000	21-1000
		1-200µl	1-200µl	100-1000µl	100-1000µl	100-1000µl	20-1250	21-1250	
VWR and VWR Signature (single channel)	0.1-2µl	✓	✓						
	0.5-10µl	✓	✓						
	2-20µl			✓	✓				
	5-50µl			✓	✓				
	10-100µl			✓	✓				
	20-200µl			✓	✓				
(multichannel)	50-250µl			✓	✓				
	100-1000µl					✓	✓	✓	✓
	1-10µl	✓	✓						
	5-50µl			✓	✓				
(multichannel)	20-200µl			✓	✓				
	50-300µl			✓	✓				



This chart is intended to be a general guide only. Your specific compatibility may vary based on your features installed and thus configuration.

FOR TECHNICAL INFORMATION, VISIT WWW.BIOLOGIXGROUP.COM

Transfer Pipets

FEATURES

- * Polyethylene pipettes will not shatter or break
- * Good alternative to pasture pipettes and rubber bulbs
- * Perfect products for quick, safe transfer of fluid
- * Long flexible stem can be bent to draw liquid from narrow or small volume tubes into the bulb
- * Uniform drop size
- * Available with gamma irradiation sterilized or non-sterilized
- * Integral, self-contained pipettes eliminate the problems of attaching rubber bulbs and suction devices or changing pipette tips
- * Good thickness distribution guarantees suction force



PIPET DESIGN

- * Available with 2 capacities of 1.0 and 3.0ml
- * Molded graduations
- * 100% inert for accurate sampling
- * Transparent wall permits easy viewing of pipette contents



PACKAGING

- * Individually package in easy-open paper/plastic pouch is available
- * Also available with bulk package

ORDERING INFORMATION

Cat #	Package	Length	Graduated To	Sterile	Unit
30-0135	Bulk	160.0mm	1ml	No	500 /pack, 10 Packs/case
30-0135A1	Individually Wrapped	160.0mm	1ml	Yes	500 /pack, 10 Packs/case
30-0138	Bulk	160.0mm	3ml	No	500 /pack, 10 Packs/case
30-0138A1	Individually Wrapped	180.0mm	3ml	Yes	500 /pack, 10 Packs/case
30-0238A1	Individually Wrapped	180.0mm	3ml	Yes	500 /pack, 6 Packs/case

PRODUCT PARAMETER

Cat #	Description	Dimensions=mm							
		A	B	C	D	E	F	G	H
30-0135	Transfer Pipets	160.0	O.D. 14.0	O.D. 2.7	84.0	12.0	21.0	O.D. 5.0	O.D. 3.5
30-0138	Transfer Pipets	160.0	O.D. 13.3	O.D. 3.2	66.7	-	14.3	O.D. 7.8	-
30-0238A1	Transfer Pipets	180.0	O.D. 13.3	O.D. 3.2	70.0	-	64.0	-	-

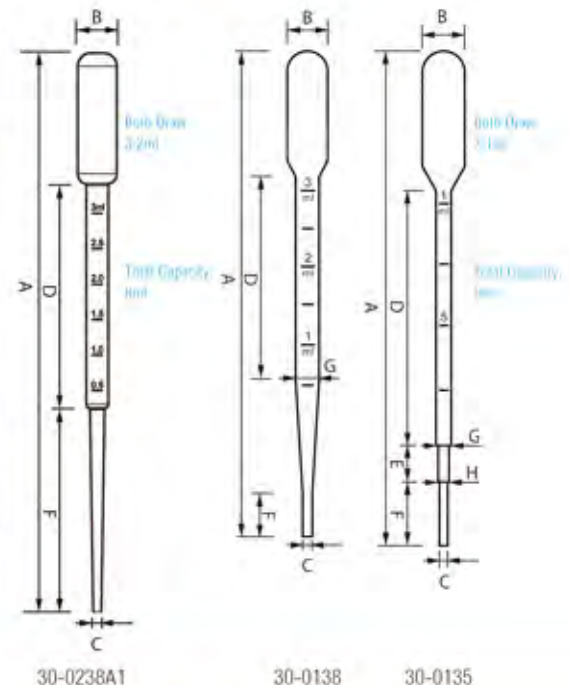

Solution Basins



FEATURES

- * Materials: PVC, polystyrene, and strong polypropylene
- * Angled sides and V-shaped bottom permits easy access to solution
- * Polypropylene basin is chemically resistant to alcohols and mild organic solvents
- * PVC basin has transparent walls to permit easy viewing of contents
- * Can be used with single or multi-channel pipettors

BASIN DESIGN

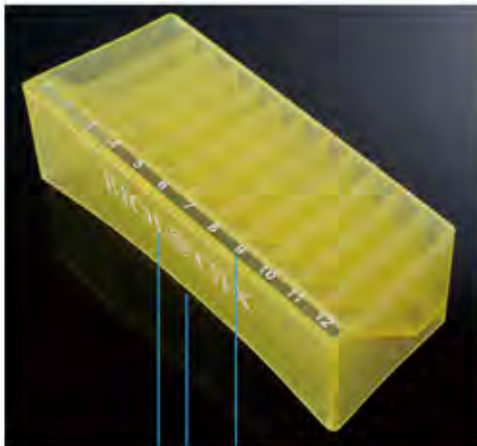

You can put your logo here

Clear numbers for easy identification

Autoclavable and reusable

- * Available in PVC super clear, polystyrene white, and polypropylene 12-channel
- * PS basins are available with 3 capacities: 25ml, 50ml, 100ml. PVC basin max capacity is 55ml
- * Polypropylene 12-channel basin: individual channels hold 5ml, flip-side is 50ml volume
- * Polypropylene basin comes in assorted colors: clear, blue, green, red, and yellow

Both sizes are functional

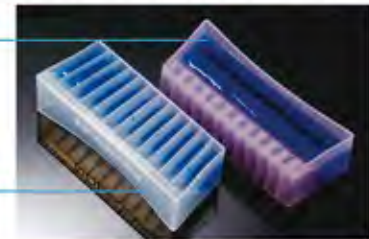

ORDERING INFORMATION

Cat #	Material	Capacity	Package	Color	Sterile	Unit
25-0052	PVC	55ml	Bulk	Clear	No	100 Pieces/pack, 8 Packs/case
25-0051	PS	55ml	Individual	White	Yes	50 Pieces/case
25-1025	PS	25ml	Individual	White	Yes	50 Pieces/case
25-1100	PS	100ml	Individual	White	Yes	50 Pieces/case
25-1202	PVC	50ml	Bulk	Assorted Colors	No	25 Pieces/pack, 4 Packs/case

PRODUCT PARAMETER

Dimensions=mm

Cat #	Description	A	B	C	D	E	F	G	H	I	J
25-0051	Solution Basin	105.9	138.3	149.0	39.4	54.5	65.2	26.2	108°	97°	84°
25-0052	Solution Basin	105.9	138.3	149.0	39.4	54.5	65.2	26.2	108°	97°	84°
25-1202	Solution Basin	38.0	49.0	7.0	111.7	124.0	40.5	29.5	-	-	-

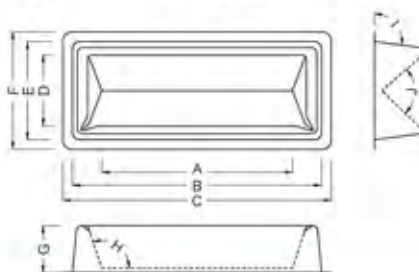

25-0051&25-0052

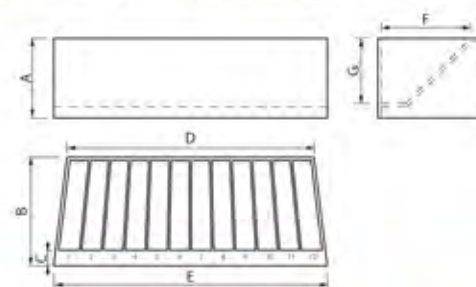

25-1202

*See Biologix Pipet Tips on page 30.

Tri-Cornered Beakers

FEATURES

- * Features a tri-corner design that provides three dripless pouring spouts
- * Six different sizes meet different needs
- * Have good impact strength and are translucent and autoclavable
- * Economical enough to be disposable and easy to clean and durable enough for reuse

BEAKER DESIGN

- * Materials: Strong, medical-grade polypropylene
- * Available in 50ml, 100ml, 250ml, 400ml, 800ml and 1,000ml

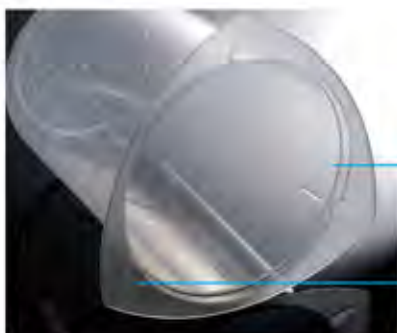

If they fall, they will not break like glass beakers do



Dripless pouring spout offers more security

ORDERING INFORMATION

Cat #	Volume	Unit/Sleeve	Sterile	Unit/Case
93-0050	50ml	25 Pieces	No	100 Pieces
93-0100	100ml	25 Pieces	No	100 Pieces
93-0250	250ml	25 Pieces	No	100 Pieces
93-0400	400ml	25 Pieces	No	100 Pieces
93-0800	800ml	25 Pieces	No	100 Pieces
93-1000	1,000ml	25 Pieces	No	100 Pieces

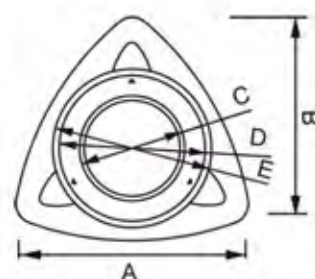

PRODUCT PARAMETER

Cat #	Description	Dimensions=mm							
		A	B	C	D	E	F	G	
93-0050	Beaker	67.0	58.0	O.D. 31.1	O.D. 43.1	O.D. 46.9	31.0	57.0	
93-0100	Beaker	84.0	72.0	O.D. 38.7	O.D. 53.7	O.D. 58.4	39.0	71.0	
93-0250	Beaker	101.0	88.0	O.D. 49.1	O.D. 68.0	O.D. 74.0	49.0	88.0	
93-0400	Beaker	114.7	99.9	O.D. 52.0	O.D. 82.0	O.D. 84.0	55.6	110.3	
93-0800	Beaker	133.1	115.2	O.D. 85.0	O.D. 104.0	O.D. 105.1	65.0	137.0	
93-1000	Beaker	140.6	121.7	O.D. 71.6	O.D. 112.7	O.D. 114.1	70.9	143.0	

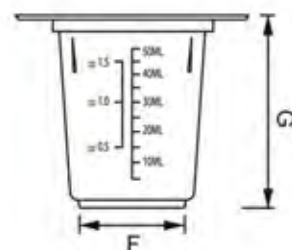

93-0050

Funnels

FEATURES

- * Made of high grade PP, resistant to most chemicals
- * Funnel comes with a short bore that works best for liquids
- * Funnel is economical, fast and efficient
- * PP material has high transparency and thermostability
- * Light weight and durable-won't break or shatter like glass
- * Autoclavable



ORDERING INFORMATION

Cat #	Diameter Top	Total Height	Sterile	Unit/Bag	Unit/Case
35-6050	60 mm	50mm	No	10 Pieces	500 Pieces

PRODUCT PARAMETER

Cat #	Description	Dimensions=mm			
		A	B	C	D
35-6050	Funnel	60.0	15.0	50.5	10.4

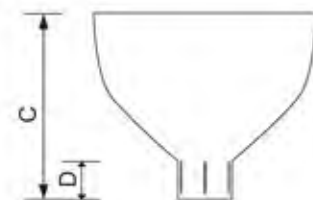
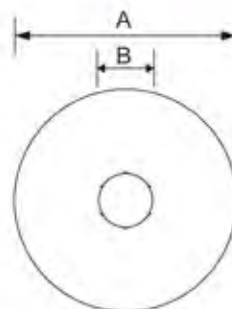

⏪ Test Tubes: Please reference page 11

*See Biologix 15ml Centrifuge Tubes from page 8 to 9.

Tissue Culture



Cell Scrapers & Lifters



FEATURES



Anti-skidding

Cell Scrapers

- * Available in two sizes: 18cm and 25cm
- * Non-pyrogenic
- * Polyethylene
- * Pivoting blade makes precise cutting and scraping movements
- * Appropriate for a variety of cell culture vessels
- * The uniquely designed handle and blade reduce cell damage during the harvesting process
- * Pre-sterilized and individually wrapped in peel-open packaging

Cell Lifters

- * Used with dishes and cell culture clusters for quick removal of cell layers
- * Blade Length: 2.0cm; Handle Length: 16cm
- * Gamma radiation sterilized and individually wrapped
- * Disposable lifters quickly remove cell layers
- * The one-piece design and chiseled blade provide improved control while minimizing damage during the cell removal process
- * Non-pyrogenic
- * Polyethylene

ORDERING INFORMATION

Cat #	Name	Handle Length	Sterile	Unit
70-1180	Cell Scraper	18cm	Yes	100 Pieces/case
70-1250	Cell Scraper	25cm	Yes	100 Pieces/case
70-2180	Cell Lifter	18cm	Yes	100 Pieces/case

PRODUCT PARAMETER

Cat #	Description	Dimensions=mm				
		A	B	C	D	E
70-1250	Cell Scraper	250.0	18.0	9	89.0	O.D. 7.7
70-1180	Cell Scraper	180.0	18.0	9	85.0	O.D. 7.4
70-2180	Cell Lifter	180.0	20.0	7.4	-	-

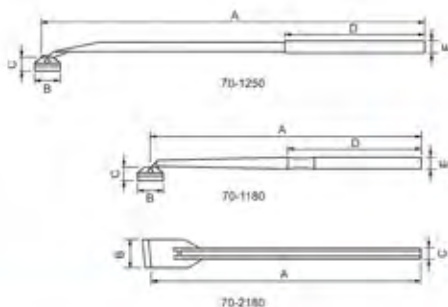

* See our full line of Petri Dishes on page 42.

Cell Strainers

FEATURES

- * Strong nylon mesh for optimal performance in a variety of applications
- * Evenly spaced mesh pores providing consistent and reliable results
- * Polypropylene frame features a molded tab for easy handling
- * Conveniently accessible in individual packaging with gamma radiation sterilization
- * Fits perfectly into 50ml Biologix Centrifuge Tubes
- * Different colors for easy pore size identification

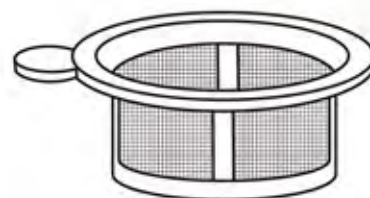

ORDERING INFORMATION

Cat #	Size	Package	Color	Sterile	Unit
15-1040	40µm	Individual	Purple	Yes	50 Pieces/case
15-1070	70µm	Individual	Orange	Yes	50 Pieces/case
15-1100	100µm	Individual	Green	Yes	50 Pieces/case

PRODUCT PARAMETER

Cat #	Description	Dimensions=mm							
		A	B	C	D	E	F	G	H
15-1040	Cell Strainers	O.D. 35.7	O.D. 25.7	O.D. 20.6	O.D. 7.8	14.4	1.5	2.8	O.D. 25.7

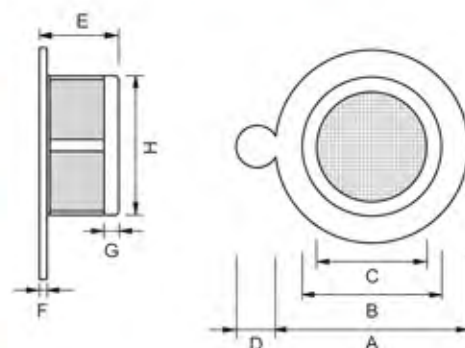

Centrifuge Tubes

For more details,
please see page 8-9



Cryogenic Vials

For more details,
please see page 20-21



Liquid Handling

For more details,
please see page 29-37

Microbiology



FEATURES

- * Easy stacking
- * Vented for better gas exchange
- * Heavy design for better heat resistance
- * Manufactured from crystal polystyrene for optimal analysis by microscopy
- * Guaranteed sterilized
- * Diameter: 90mm; 60mm; 150mm; height: 15 mm

Petri Dishes



Glass-like clarity



Easy stacking



Vents for gas exchange

ORDERING INFORMATION

Cat #	Size	Color	Sterile	Unit
66-1560	60x15mm	Clear	Yes	10 Pieces/bag, 50 Bags/case
66-1501	90x15mm	Clear	Yes	10 Pieces/bag, 50 Bags/case
66-1515	150x15mm	Clear	Yes	10 Pieces/bag, 20 Bags/case

PRODUCT PARAMETER

Cat #	Description	Dimensions=mm							
		A	B	C	D	E	F	G	H
66-1501	Petri Dishes	O.D. 89.3	O.D. 86.5	7.9	6.7	14.9	13.4	16.1	1.2
66-1560	Petri Dishes	O.D. 57.4	O.D. 53.8	10.1	8.7	14.2	12.7	15.5	1.4

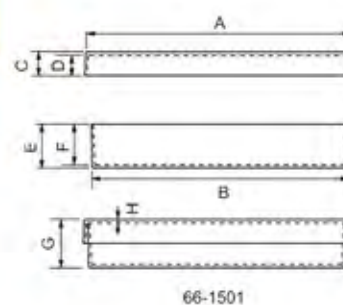
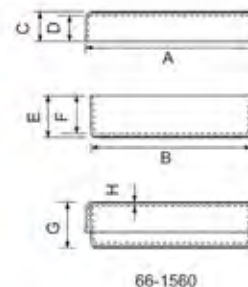

*See our full line of Inoculation loops, needles and spreaders from page 43 to 44.

*See our full line of Cell Scrapers and Lifters on page 39.

Cell Spreaders



FEATURES

- * Ideal for even spreading of bacterial cultures
- * Disposable
- * Smooth spreading surface with slight upward angle reduces the risk of damaging agar surface
- * L-shape allows application on the entire Petri Dish or plate surface
- * Gamma radiation sterilized
- * Polystyrene

PACKAGING



- * Available in individually wrapped and 10 pieces per bag which keep them safe from contamination and easy to be used
- * 10 pieces pack includes a piece of cardboard with product description to better protect products and the bag can be resealed

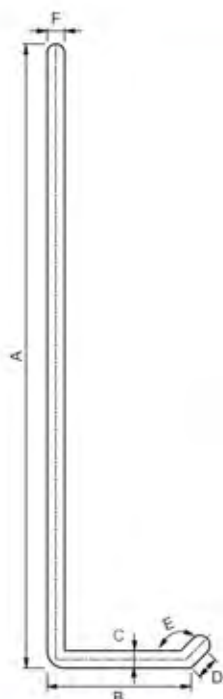

ORDERING INFORMATION

Cat #	Pack	Color	Sterile	Unit
65-1001	Individual	Orange	Yes	500 Pieces/case
65-1010	10 Pieces/pack	Orange	Yes	500 Pieces/case

PRODUCT PARAMETER

Cat #	Description	Dimensions=mm					
		A	B	C	D	E	F
65-1001	Cell Spreader	144.0	33.2	O.D.4.0	O.D. 5.3	135°	O.D. 4.0

*See Biologix Petri Dishes on page 42.

Inoculating Loops & Needles

FEATURES

- * High impact polystyrene loops and needles are smooth and flexible to facilitate uniform and smooth streaking without damaging the gel surface
- * Needles are straight and suitable for removal of specimens of single colonies
- * Packed sterile in safe, tamper proof, zip-seal resealable bags
- * The other end of the loops can be used as needles
- * Freedom from lubricants, oils and electrostatic charges enables consistent wetting and complete liquid transfer

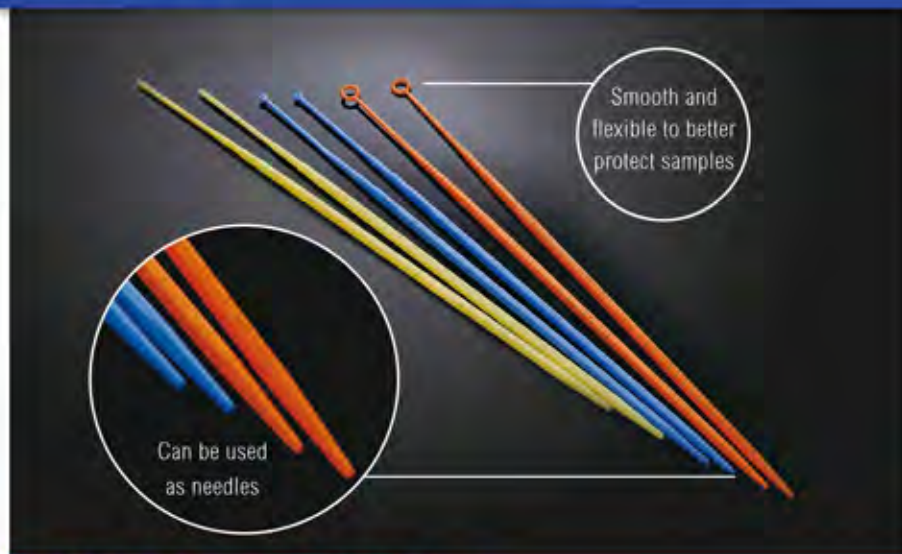
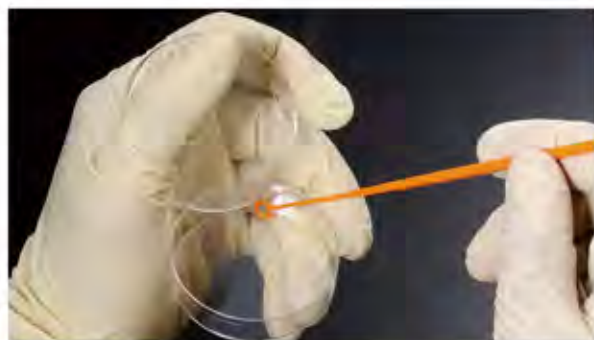

LOOP/NEEDLE DESIGN

- * Loops available in 1µl and 10µl sizes
- * Needles are ideal for the removal of single colonies
- * Ultra-smooth loop surface

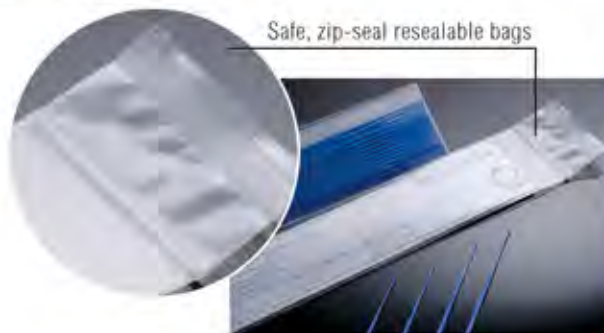

PACKAGING

- * 25 Pieces per bag keep them safe from contamination and easy to be used
- * 25 pieces pack includes a piece of cardboard with product description to better protect products and the bag can be resealed

ORDERING INFORMATION

Cat #	Size	Description	Color	Sterile	Unit
65-0001	1µl	Loops	Blue	Yes	25 Pieces/pack, 1,000 Pieces/case
65-0010	10µl	Loops	Orange	Yes	25 Pieces/pack, 1,000 Pieces/case
65-0002	-	Needles	Yellow	Yes	25 Pieces/pack, 1,000 Pieces/case

PRODUCT PARAMETER

Cat #	Description	Dimensions=mm							
		A	B	C	D	E	F	G	H
65-0010	Inoculating Loop	200.0	130.0	66.8	O.D. 3.6	O.D. 6.5	O.D.2.7	O.D. 3.1	O.D.3.8
65-0001	Inoculating Loop	198.3	130.0	66.8	O.D. 0.8	O.D. 3.0	O.D.2.7	O.D. 3.1	O.D.3.8
65-0002	Inoculating Needle	198.5	131.7	66.8	O.D. 1.5	O.D. 2.7	O.D.3.1	O.D. 3.8	-

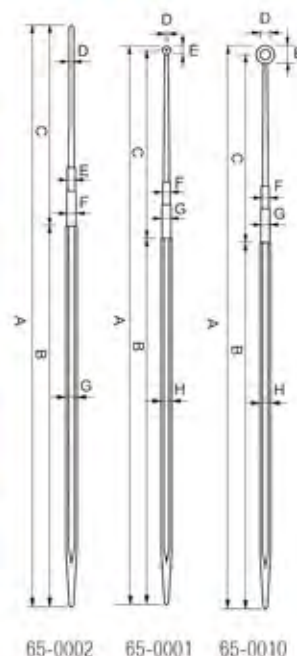

*See Biologix Petri Dishes on page 42.

Histology

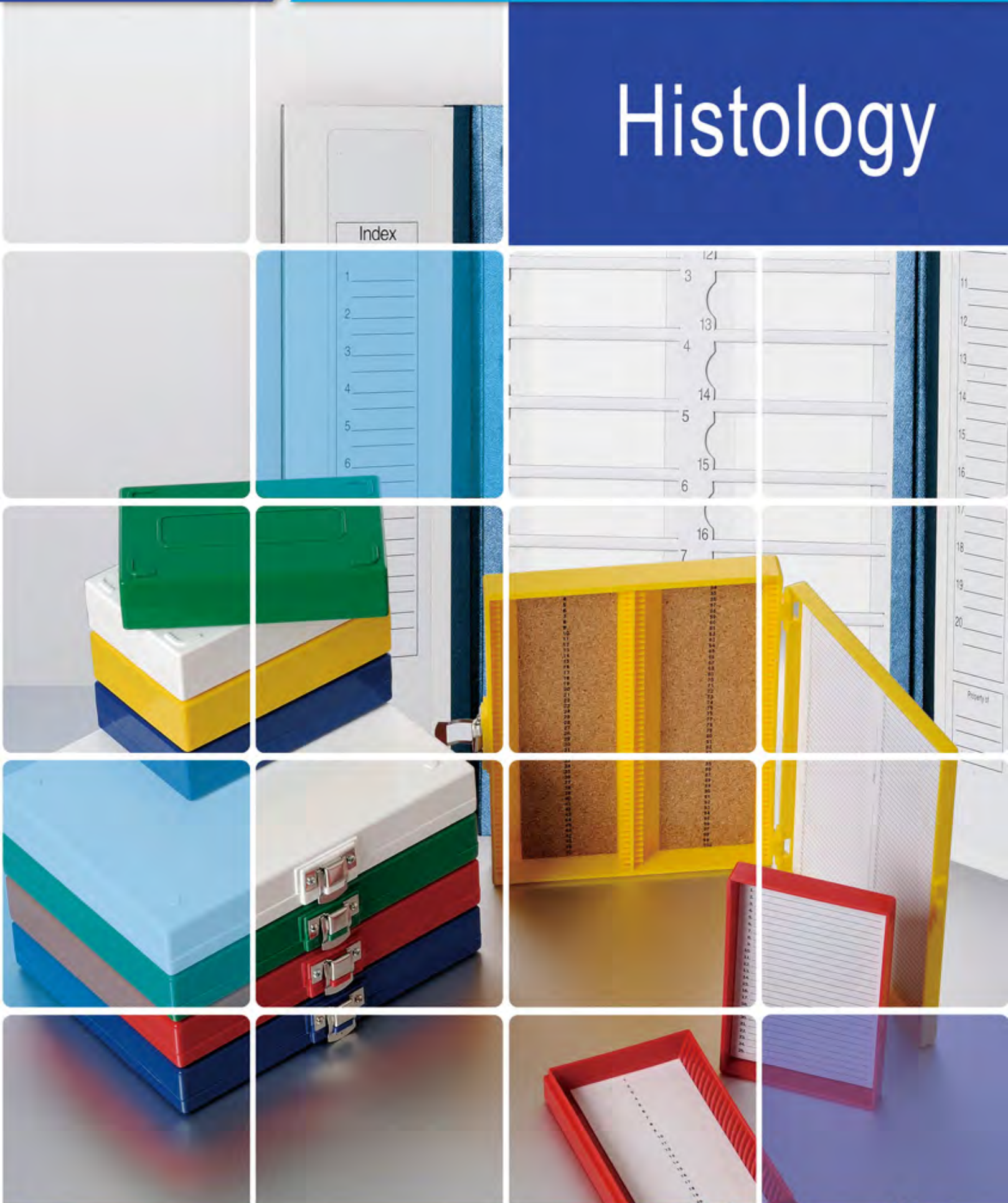

Slide Storage Boxes

FEATURES

- * Made from strong ABS material which is unaffected by humidity and is thoroughly insect proof
- * Store 1" x 3" (25mm x 75mm) microscope slides
- * Superior design prevents slides breakage and block dust from contaminating slides
- * Each slot is numbered to correspond to the slide inventory sheet on the inside cover
- * The 100-place box is secured with a rust-resistant clasp and hinge pin



BOX DESIGN

- * Available in 25-place or 100-place volume
- * Choose from either traditional cork or foam
- * 5 assorted colors (red, yellow, green, blue, and white) make the boxes easy to identify
- * Boxes are stackable to save space



- This is easy to be labeled
- Easy for each sample notes
- Rust-resistant clasp to secure the box
- Stackable to save space

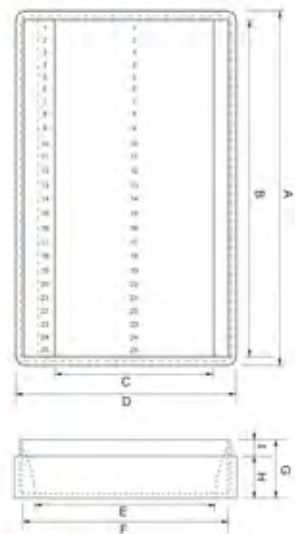

41-6025



41-6025C

ORDERING INFORMATION

Cat #	Description	Lining	Place	Sterile	Unit
41-5025	Assorted Colors	Foam	25-place	No	20 Pieces/case
41-5100	Assorted Colors	Foam	100-place	No	20 Pieces/case
41-6025	Assorted Colors	Cork	25-place	No	20 Pieces/case
41-6100	Assorted Colors	Cork	100-place	No	20 Pieces/case

PRODUCT PARAMETER

Cat #	Description	Dimensions=mm								
		A	B	C	D	E	F	G	H	I
41-6025	Box	140.0	133.0	62.5	88.0	71.4	80.0	23.0	16.4	6.6
41-6025C	Lid	140.0	137.0	82.8	88.0	13.7	16.1	-	-	-

*See Biologix Microscope Slides on page 47.

Microscope Slides

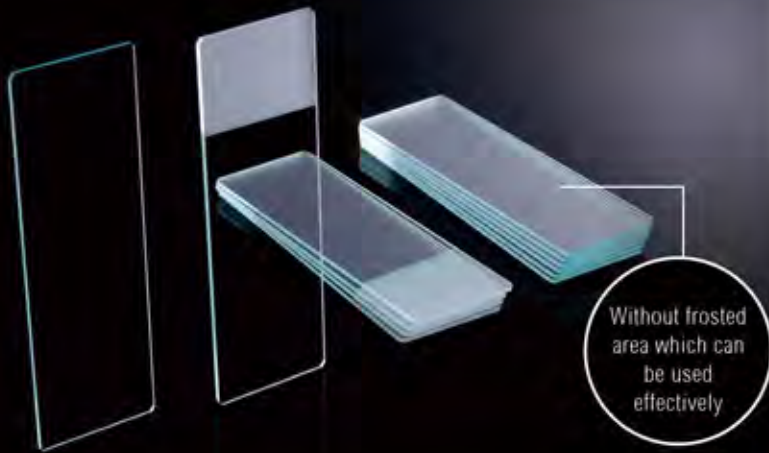

FEATURES

- * The slides are with clean glass surface
- * Ground edges prevent personal injury and chipping of glass caused by the cut edges
- * The glass slide end faces are polished
- * The slides without frosted area can be effectively used
- * The slides with frosted area are convenient for classification and storage

Polished end prevents personal injury

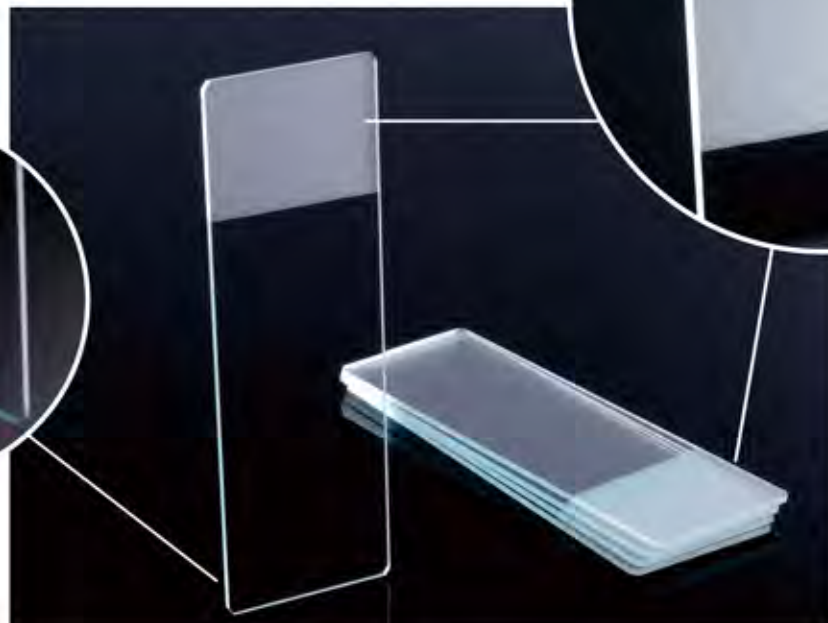
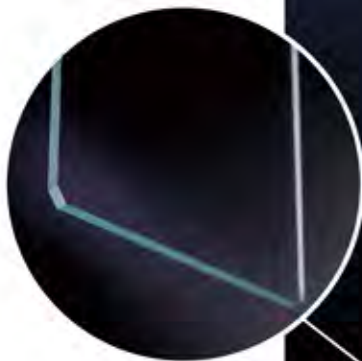

With frosted end and pencils can write on the area. Since the written characters are indelible in staining fluids or solvents, the glass slides of this type are convenient for classification and storage.

ORDERING INFORMATION

Cat #	Material	Type	Size	Sterile	Unit
7101	Clear Glass	Plain Slides	25.4 x 76.2mm	No	72 Pieces/pack, 50 Packs/case
7105	Clear Glass	Single Frosted End	25.4 x 76.2mm	No	72 Pieces/pack, 50 Packs/case

*See Biologix Slide Storage Boxes and Slide Mailers on page 46 and 48.

Slide Mailers

FEATURES

- * Made of sturdy cardboard to protect slides
- * Finger slots for easy removal of slides
- * Folding lids protect samples on slides
- * Storage and a safe transport method of microscope slides

DESIGN

- * Available in 20-place volume
- * 20-place mailer includes an inventory sheet and storage box
- * For 20-place mailers, they are packed 10 pieces in one inner durable pack to better protect products

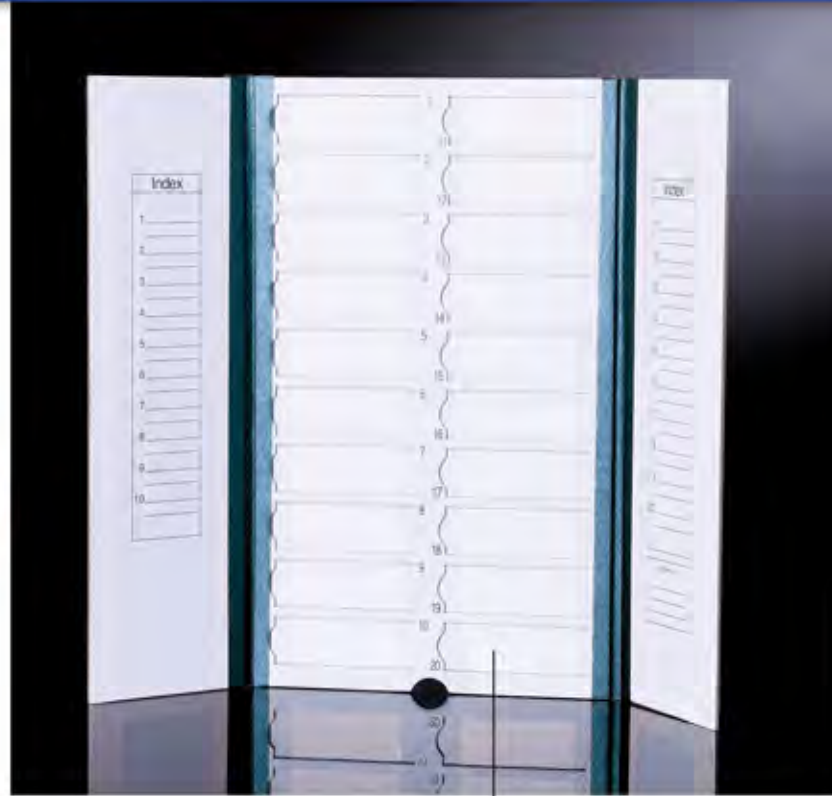

- Sturdy cardboard to protect slides
- Packed by durable box to better protect mailers
- Finger slots for easy removal of slides
- The writing area is easy for notes

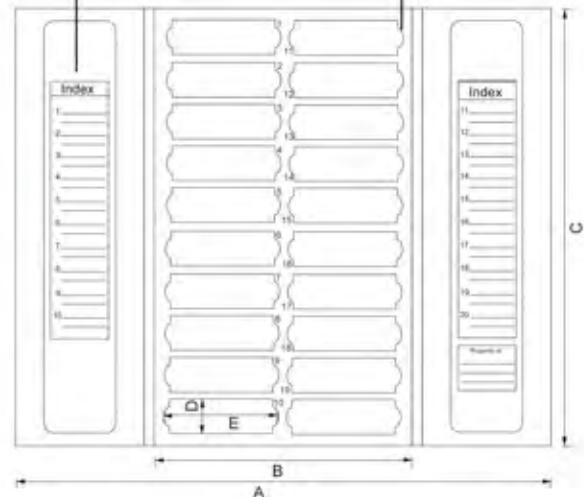

ORDERING INFORMATION

Cat #	Place	Sterile	Unit
41-4020	20-place	No	10 Pieces/pack, 4 Packs/case

PRODUCT PARAMETER Dimensions=mm

Cat #	Description	A	B	C	D	E
41-4020	Slide Mailers	415.0	340.0	200.0	26.0	82.0

*See Biologix Microscope Slides on page 47.

41-4020

Drosophila Vials

FEATURES

- * Vials are precision moulded from premium grade polystyrene
- * Glass-like clarity for easy sample viewing
- * Disposable vials are a safe and cost-saving alternative to glass vials

The tray pack is great for quick, effortless filling

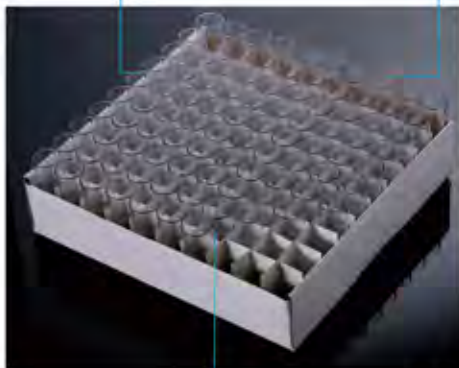

Light weight and easy for handling



You can put your logo here



VIAL DESIGN

- * Available in narrow (25 x 95mm) and wide (28.5 x 95mm)
- * Both narrow and wide vials are available in bulk and tray packaging
- * The tray pack 10 x 10 row configuration is great for quick, effortless filling



If they fall, they will not break like glass vials do

ORDERING INFORMATION

Cat #	Description	Size	Pack	Sterile	Unit
51-0500	Narrow	25 x 95mm	Bulk	No	25 Pieces/bag, 500 Pieces/case
51-0501	Narrow	25 x 95mm	Tray	No	100 Pieces/rack, 500 Pieces/case
51-0800	Wide	28.5 x 95mm	Bulk	No	25 Pieces/bag, 500 Pieces/case
51-0801	Wide	28.5 x 95mm	Tray	No	100 Pieces/rack, 500 Pieces/case

PRODUCT PARAMETER

Cat #	Description	Dimensions=mm		
		A	B	C
51-0500	Drosophila Vial	95	O.D. 22.6	O.D. 25
51-0800	Drosophila Vial	95	O.D. 25.4	O.D. 28.5

*See Biologix Drosophila Plugs on page 52.



Drosophila Bottles



FEATURES

- * Made of polypropylene and can be autoclaved, yet are economical enough to throw away after single use
- * A pliable top permits easy closure removal
- * The square-bottom is also transparent and features a firm, stiff neck for easier handling

BOTTLE DESIGN



- * 6oz (177ml) bottle
- * Molded graduations in 25ml increments up to 100ml
- * Square bottom
- * Available in both bulk and tray packaging

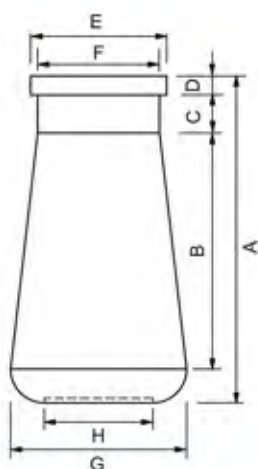

ORDERING INFORMATION

Cat #	Pack	Sterile	Unit
51-17720	Bulk Pack	No	200 Pieces/bag, 200 Pieces/case
51-17721	Rack Pack	No	25 Pieces/rack, 200 Pieces/case

PRODUCT PARAMETER

Cat #	Description	Dimensions=mm							
		A	B	C	D	E	F	G	H
51-17720	Drosophila Bottle	103.3	74.6	12.0	6.0	0.D.43.0	0.D.38.5	55.6	34.2

*See Biologix Drosophila Plugs on page 52.

Drosophila Plugs

FEATURES

- * Made of high density foam
- * Offer minimal shedding as well as reduce evaporation
- * Superior barrier to mite infestation
- * Exact fit with narrow 0.9 in. (25mm) or wide 1.1 in. (28.5mm) diameter vials or 6oz (177ml) bottles
- * Stretches yet maintains tight fit after repeated removal and closing
- * Flat surface accepts marking pen



Flat surface accepts marking pen

Fit well with bottles



Fit well with Vials

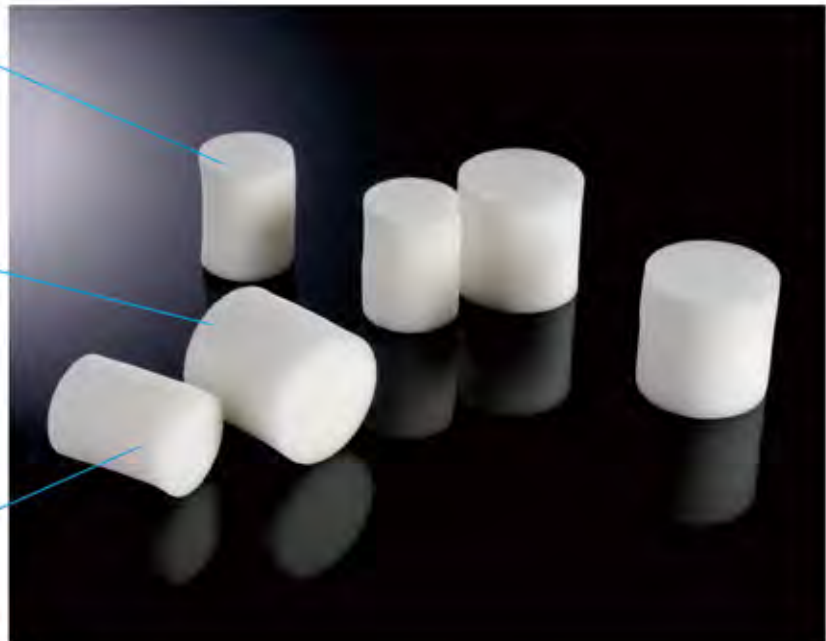

ORDERING INFORMATION

Cat #	Applied #	Fits	Sterile	Unit
51-0505	51-0500/0501	Narrow Plastic Vials	No	100 Pieces/bag, 10 Bags/case
51-0805	51-0800/0801	Wide Plastic Vials	No	100 Pieces/bag, 10 Bags/case
51-17725	51-17720/17721	6oz Plastic Bottles	No	100 Pieces/bag, 10 Bags/case

*See Biologix Drosophila Vials and Bottles from page 50 to 51.

Racks & Boxes



Racks and Boxes

Tube Racks

For more details, please see page 12.



Stainless Steel Freezer Racks

For more details, please see page 26-28.



Premium Cardboard Freezer Boxes

For more details, please see page 22.



ID-Color™ Cardboard Freezer Boxes

For more details, please see page 23.



Plastic Freezer Boxes

For more details, please see page 24-25.



Gloves

FEATURES



Powder Free Latex Disposable Gloves

- * Powder-free, single chlorinated to provide good dry hand donning capability
- * Full textured surface enhances grip for efficient instrument handling
- * Good grip to handle dry instruments when moderate amount of handling is required
- * Good Thickness Distribution for tactile sensitivity
- * Suitable for all types of medical examination, home care and diagnostic and laboratory use
- * Biocompatibility Tested (ISO 10993)
- * Ambidextrous
- * Non-Sterile
- * Natural to Light Yellow Color



Powder Free Nitrile Disposable Gloves

- * Non-added components (sulphur and accelerator chemicals) to minimize exposure to Type IV hypersensitivity
- * Non-latex formulation eliminates exposure to Type 1 latex protein sensitivity
- * Nitrile material promotes better puncture and chemical/ chemo resistance properties
- * Low Dermatitis Potential Claim
- * Finger textured with improved working grip to enable efficient instrument handling in wet and dry condition
- * Beaded cuff design to don gloves efficiently and securely
- * Extra Length
- * Biocompatibility Tested (ISO 10993)
- * Ambidextrous
- * Non-Sterile
- * Dark Blue Color



ORDERING INFORMATION

Cat #	Description	Size	Color	Sterile	Unit
97-1111	Latex	XS	Nature to Light Yellow	No	100 Pieces/pack, 10 Packs/case
97-1112	Latex	S	Nature to Light Yellow	No	100 Pieces/pack, 10 Packs/case
97-1113	Latex	M	Nature to Light Yellow	No	100 Pieces/pack, 10 Packs/case
97-1114	Latex	L	Nature to Light Yellow	No	100 Pieces/pack, 10 Packs/case
97-1115	Latex	XL	Nature to Light Yellow	No	100 Pieces/pack, 10 Packs/case
97-6111	Nitrile	XS	Dark Blue	No	100 Pieces/pack, 10 Packs/case
97-6112	Nitrile	S	Dark Blue	No	100 Pieces/pack, 10 Packs/case
97-6113	Nitrile	M	Dark Blue	No	100 Pieces/pack, 10 Packs/case
97-6114	Nitrile	L	Dark Blue	No	100 Pieces/pack, 10 Packs/case
97-6115	Nitrile	XL	Dark Blue	No	100 Pieces/pack, 10 Packs/case

Application Guidelines

Maximum centrifugal acceleration force can be influenced by following criteria:

- * Use of organic solutions, temperature below 0°C, centrifuging without centrifuge adapter, etc. Conduct a trial run to determine proper conditions before any critical use begins.
- * The RCF or G (relative centrifugal force) ratings for the disposable centrifuge tubes have been established at room temperature using tubes filled to nominal capacity with water and centrifuge for 30 minutes. The centrifuge must be equipped with the recommended carriers, adapters, and cushions that fully support the tubes. If an angle head rotor is used or proper support is not provided, G values will be lower.
- * Do not confuse speed or revolutions per minute (RPM) with relative centrifugal force (RCF). Instructions for centrifuging a sample at a given RPM and time are incomplete unless the rotor or radius is specified. Protocols should always state the time and RCF value for centrifuging a sample.

Autoclaving guideline for Plastics

To ensure successful steam sterilization of your plastic labware please adhere to the following guideline:

Autoclave all plastic consumables at 121°C for 15 minutes, 15psi/1 atm. Do not use a dry cycle as this may cause deformation or weakening of the plastic. Allow temperature within the autoclave to return to at least 80°C before removing product.

NOT ALL PRODUCTS ARE AUTOCLAVABLE.

Our Commitment in Quality

At Biologix, we look at quality from every angle in terms of functionality, safety, purity, formulation, consistency, manufacturing, customer service, technical support and many more-to consistently ensure customer satisfaction.

Under our detailed QA/QC procedures for our facility, each and every product are traceable by lot, regardless of packaging format. They must go through a five-step, human inspection before it is released for packaging.

Our facility is completely equipped with the latest instruments and technology from the most trusted manufacturers which ensures that Biologix applies the most stringent standards to certify products to be free from RNase, DNase, endotoxin (pyrogens), etc.

In addition to being ISO 9001:2008, CE, and FDA compliant, we also make available to our customers lot specific certificates such as Sterilization Certificates, Nucleases Free Certificates, Certificate of Origin, etc. Certificates of Compliance can also be downloaded and printed directly from our website: www.BiologixGroup.com.

Note: Product parameters within this catalogue are for reference only.

Chemical Resistance Form

For Biologix Plastic Laboratory Supplies

	PS	PP	HDPE	LDPE	PVC	CA	PC	CN	NY	MCE	PTFE	PET
Acids												
Hydrochloric acid (25%)	G	G	G	G	G	N	R	R	N	O	R	R
Hydrochloric acid (concentrated)	F	G	G	G	F	N	R	N	N	N	R	O
Nitric acid (concentrated)	P	P	N	N	P	N	R	N	N	N	O	N
Nitric acid (25%)	P	G	F	F	F	N	R	L	N	O	R	R
Alcohols												
Butanol	G	G	G	G	G	R	R	R	R	R	R	R
Ethanol	G	G	G	G	G	R	R	N	R	O	R	R
Methanol	G	G	G	G	G	R	R	N	R	O	R	R
Amines												
Aniline	G	G	G	G	P	N	N	R	R	N	R	O
Dimethylformamide	P	G	G	G	F	N	N	N	R	N	R	N
Bases												
Ammonium hydroxide (25%)	F	G	G	G	G	R	N	R	R	O	N	O
Ammonium hydroxide (1N)	F	G	G	G	G	N	N	R	R	O	N	N
Sodium hydroxide	G	G	G	G	G	N	N	N	R	N	R	N
Hydrocarbons												
Hexane	P	G	G	G	F	R	R	R	R	R	R	R
Toluene	P	G	N	N	P	R	O	R	R	R	R	N
Xylene	P	F	P	N	P	R	R	R	R	R	R	N
Dioxane	P	G	G	F	P	N	N	N	R	N	R	R
Dimethylsulfoxide (DMSO)	P	G	G	G	P	N	N	N	R	N	R	O*
Halogenated Hydrocarbons												
Chloroform	P	G	P	N	P	N	N	R	R	N	R	R
Methylene chloride	P	F	P	N	P	N	N	R	R	N	R	N
Ketones												
Acetone	P	G	G	G	P	N	O	N	R	N	R	R
Methyl ethyl diketone	P	G	G	G	P	N	O	N	R	O	R	R

*Can be used with aqueous solutions containing up to 20% DMSO.
The above chemical resistance chart is meant to be used as a guide only.

LEGEND

R= Recommended	F= Fair	PS =Polystyrene	PTFE = Polytetrafluorethylene (Teflon)
L= Limited Resistance	G= Good	PP=Polypropylene	CN = Cellulose Nitrate
N= Not Recommended	P= Poor	PVC =Polyvinyl Chloride	NY = Nylon
O= Testing Advised		CA =Cellulose Acetate	MCE = Mixed Cellulose Esters
		PC = Polycarbonate	PET= Polyethylene Terephthalate



BIOL@GIX

Biologix Group Ltd

9876 Pflumm Rd
Lenexa, KS 66215 USA

Phone: +1-816-6597165

Inquiry@BiologixGroup.com
www.BiologixGroup.com

